

ELECTRONIC SNAP CIRCUITS®

Projects 306-511

AGE
8 - 108

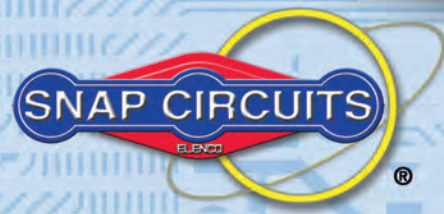
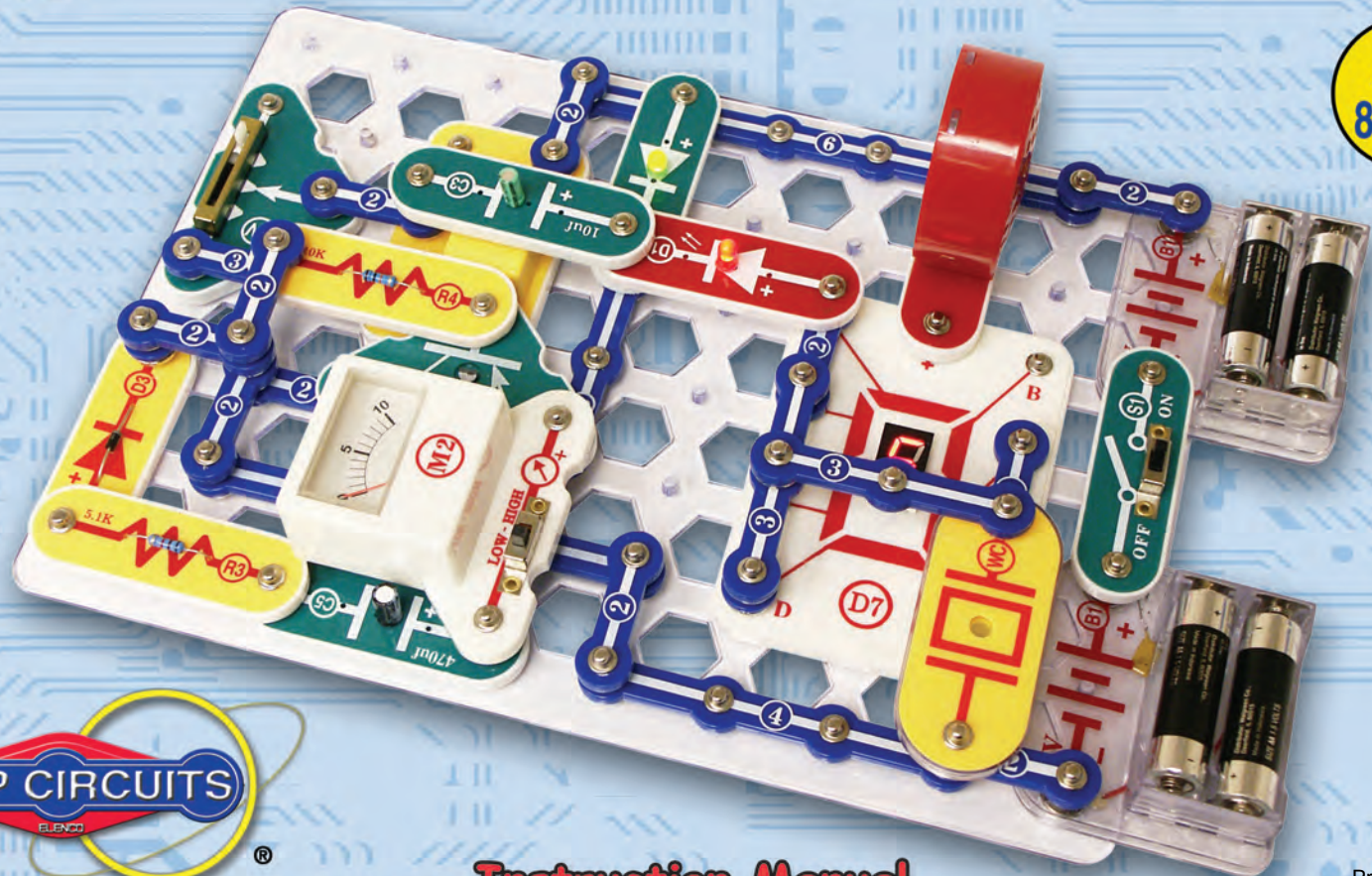

Instruction Manual

Project 317

ELENCO®

Table of Contents

Basic Troubleshooting	1
Parts List	2
<i>MORE</i> About Your Snap Circuits® Parts	3, 4
<i>MORE</i> Advanced Troubleshooting	4
<i>MORE</i> DO's and DON'Ts of Building Circuits	5
Project Listings	6, 7
Projects 306-511	8 - 61
Other Snap Circuits® Products	62



WARNING: SHOCK HAZARD - Never connect Snap Circuits® to the electrical outlets in your home in any way!



WARNING: CHOKING HAZARD - Small parts. Not for children under 3 years.



WARNING FOR ALL PROJECTS WITH A SYMBOL

Moving parts. Do not touch the motor or fan during operation. Do not lean over the motor. Do not launch the fan at people, animals, or objects. Eye protection is recommended.



Batteries:

- Use only 1.5V AA type, alkaline batteries (not included).
- Insert batteries with correct polarity.
- Non-rechargeable batteries should not be recharged. Rechargeable batteries should only be charged under adult supervision, and should not be recharged while in the product.
- Do not mix alkaline, standard (carbon-zinc), or rechargeable (nickel-cadmium) batteries.
- Do not mix old and new batteries.
- Remove batteries when they are used up.
- Do not short circuit the battery terminals.
- Never throw batteries in a fire or attempt to open its outer casing.
- Batteries are harmful if swallowed, so keep away from small children.
- Do not connect batteries or battery holders in parallel.

WARNING: Always check your wiring before turning on a circuit. Never leave a circuit unattended while the batteries are installed. Never connect additional batteries or any other power sources to your circuits. Discard any cracked or broken parts.

Adult Supervision: Because children's abilities vary so much, even with age groups, adults should exercise discretion as to which experiments are suitable and safe (the instructions should enable supervising adults to establish the experiment's suitability for the child). Make sure your child reads and follows all of the relevant instructions and safety procedures, and keeps them at hand for reference.

This product is intended for use by adults and children who have attained sufficient maturity to read and follow directions and warnings.

Never modify your parts, as doing so may disable important safety features in them, and could put your child at risk of injury.

Basic Troubleshooting

1. Most circuit problems are due to incorrect assembly. Always double-check that your circuit exactly matches the drawing for it.
2. Be sure that parts with positive/negative markings are positioned as per the drawing.
3. Be sure that all connections are securely snapped.
4. Try replacing the batteries.
5. If the motor spins but does not balance the fan, check the black plastic piece with three prongs on the motor shaft. Be sure that it is at the top of the shaft.

Elenco® is not responsible for parts damaged due to incorrect wiring.

Note: If you suspect you have damaged parts, you can follow the Advanced Troubleshooting procedure on page 4 to determine which ones need replacing.

Review of How To Use It (See page 3 of the Projects 1-101 manual for more details.)

The Snap Circuits® kit uses building blocks with snaps to build the different electrical and electronic circuits in the projects. These blocks are in different colors and have numbers on them so that you can easily identify them. The circuit you will build is shown in color and with numbers, identifying the blocks that you will use and snap together to form a circuit.

Next to each part in every circuit drawing is a small number in black. This tells you which level the component is placed at. Place all parts on level 1 first,

then all of the parts on level 2, then all of the parts on level 3, etc.

A large clear plastic base grid is included with this kit to help keep the circuit block together. The base has rows labeled A-G and columns labeled 1-10.

Install two (2) "AA" batteries (not included) in the battery holder (B1). The 2.5V and 6V bulbs come packaged separate from their sockets. Install the 2.5V bulb in the L1 lamp socket, and the 6V bulb in the L2 lamp socket.

Place the fan on the motor (M1) whenever that part is used, unless the project you are building says not to use it.







Some circuits use the red and black jumper wires to make unusual connections. Just clip them to the metal snaps or as indicated.

Note: While building the projects, be careful not to accidentally make a direct connection across the battery holder (a "short circuit"), as this may damage and/or quickly drain the batteries.

Parts List (Colors and styles may vary) Symbols and Numbers

Note: There are additional part lists in your other project manuals. Part designs are subject to change without notice.

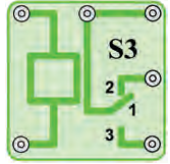
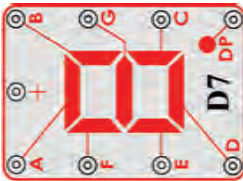
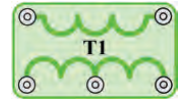
Important: If any parts are missing or damaged, **DO NOT RETURN TO RETAILER.** Call toll-free (800) 533-2441 or e-mail us at: help@elenco.com. Customer Service • 150 Carpenter Ave. • Wheeling, IL 60090 U.S.A.

Qty.	ID	Name	Symbol	Part #	Qty.	ID	Name	Symbol	Part #
☐ 3	(2)	2-Snap Wire		6SC02	☐ 1	(M2)	Analog Meter		6SCM2
☐ 1	(5)	5-Snap Wire		6SC05	☐ 1	(Q3)	SCR		6SCQ3
☐ 1	(D3)	Diode 1N4001		6SCD3	☐ 1	(S3)	Relay		6SCS3
☐ 1	(D7)	7-Segment LED Display		6SCD7	☐ 1	(T1)	Transformer		6SCT1
☐ 1	(FM)	FM Module		6SCFM	☐ 1	(U6)	Recording Integrated Circuit		6SCU6

You may order additional / replacement parts at our website: www.snapcircuits.net

MORE About Your New Snap Circuits® Parts (Note: There is additional information in your other project manuals).

Our Student Guides give much more information about your parts, along with a complete lesson in basic electronics. See www.snapcircuits.net/learn.htm or page 62 for more information.

(Part designs are subject to change without notice).

The **FM module (FM)** contains an integrated FM radio circuit. Refer to the figure below for the pinout description:

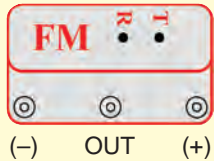

FM Module:

- (+) - power from batteries
- (-) - power return to batteries
- T - tune up
- R - reset
- OUT - output connection

See project #307 for example of proper connections.

The **meter (M2)** is a very important indicating and measuring device. You'll use it to measure the amount of current or voltage depending on the circuit configuration. Notice the meter has a "+" sign, indicating the positive terminal (+ power from the batteries). The other snap is the negative terminal (- power return to batteries). The meter has a switch to change between scales, indicated as LOW and HIGH (or 10mA and 1A).

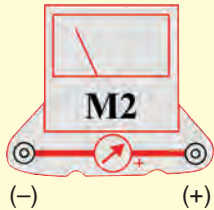

Meter:

- (+) - power from batteries
- (-) - power return to batteries

The **recording IC module (U6)** contains an integrated recording circuit. You can record a message up to five seconds long. There are also three pre-recorded songs. Refer to the figure below for the pinout descriptions:



Recording IC Module:

- (+) - power from batteries
- (-) - power return to batteries
- RC - record
- Play - play
- OUT - output connection
- Mic + - microphone input
- Mic - - microphone input

See project #308 for example of proper connections.

The **relay (S3)** is an electronic switch with contacts that can be closed or opened. It contains a coil that generates a magnetic field when current flows through it. The magnetic field attracts an iron armature, which switches the contacts (see figure).

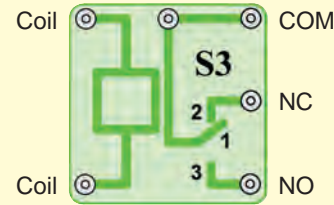

Relay:

- Coil - connection to coil
- Coil - connection to coil
- NC - normally closed contact
- NO - normally open contact
- COM - Common

See project #341 for example of proper connections.

The **transformer (T1)** consists of two coil windings on one core. One coil is called the Primary (input) and the other the Secondary (output). The purpose of the transformer is to increase the amount of AC voltage applied to the primary. This transformer is a step-up transformer.

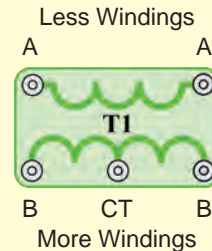

Transformer:

- A - less windings side
- A - less windings side
- B - more windings side
- B - more windings side
- CT - center tap

See project #347 for example of proper connections.

Diode (D3) - Think of a diode as a one-way valve that permits current flow in the direction of the arrow. The anode (arrow) is the positive side, and the cathode (bar) is the negative. The diode conducts or turns on when the voltage at the anode is 0.7V or greater.



Diode:

- Anode - (+)
- Cathode - (-)

MORE About Your Snap Circuits® Parts (continued)

SCR (Q3) - An SCR is a three-pin (anode, cathode and gate) silicon-controlled rectifier diode. Like a standard diode, it permits current flow in only one direction. It will only conduct in the forward direction when triggered by a short pulse (or steady voltage applied) between the gate and cathode terminals. **A high current may damage this part, so the current must be limited by other components in the circuit.**

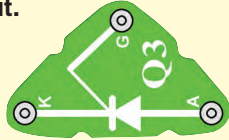

SCR:

A - Anode
K - Cathode
G - Gate

The **7-segment display (D7)** is found in many devices today. It contains 7 LED's that have been combined into one case to make a convenient device for displaying numbers and some letters. The display is a common anode version. That means that the positive leg of each LED is connected to a common point which is the snap marked "+". Each LED has a negative leg that is connected to one snap. To make it work you need to connect the "+" snap to positive three volts. Then to make each segment light up, connect the snaps of each LED to ground. In the projects, a resistor is always connected to the "+" snap to limit the current. **A high current may damage this part, so the current must be limited by other components in the circuit.**

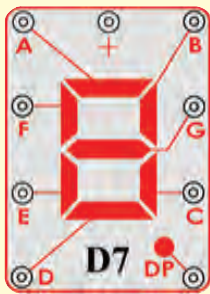

7-segment Display:

(+) - power from batteries
A - Segment A
B - Segment B
C - Segment C
D - Segment D
E - Segment E
F - Segment F
G - Segment G
DP - Decimal Point

See project #337 for example of proper connections.

MORE Advanced Troubleshooting (Adult supervision recommended)

Elenco® is not responsible for parts damaged due to incorrect wiring.

If you suspect you have damaged parts, you can follow this procedure to systematically determine which ones need replacing:

1 - 20. Refer to project manuals 1 & 2 (projects #1-101, #102-305) for testing steps 1-20, then continue below.

21. **FM Module (FM):** Build project #307, you should hear FM radio stations.

22. **Meter (M2):** Build the mini-circuit shown here and set the meter switch to LOW (or 10mA), the meter (M2) should deflect full scale. Then, replace the 10kΩ resistor (R4) with the 2.5V lamp (L1), and set the meter switch to HIGH (or 1A). The meter should deflect to 1 or higher.

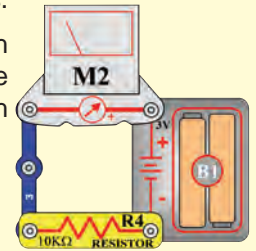

23. **Recording IC (U6):** Build project #308. Make an 8 second recording, then listen to the three prerecorded songs.

24. **Relay (S3):** Build project #341. The red LED (D1) should be on when the slide switch (S1) is on, and the green LED (D2) should be on when the switch is off.

25. **Transformer (T1):** Build the mini-circuit shown here. Pressing the press switch (S2) flashes the green LED (D2). Connect the jumper wire to the CT point. Pressing the press switch flashes the green LED.

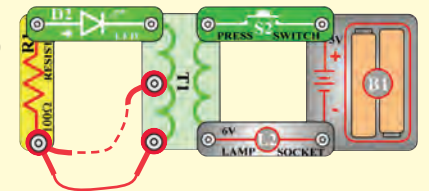

26. **Diode (D3):** Build the mini-circuit shown here, the red LED (D1) should light. Reverse the direction of the diode, the LED should not light now.

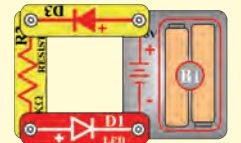

27. **SCR (Q3):** Build the mini-circuit shown here. Turn on the slide switch (S1) and the motor (M1) should not spin. Press the press switch (S2), the motor should start spinning. Now turn the slide switch off and on, the motor should not spin.

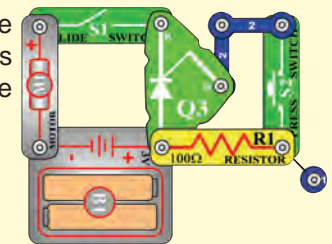

28. **7-Segment Display (D7):** Build project #337. All segments light, displaying the number 8.

MORE DO's and DON'Ts of Building Circuits

After building the circuits given in this booklet, you may wish to experiment on your own. Use the projects in this booklet as a guide, as many important design concepts are introduced throughout them. Every circuit will include a power source (the batteries), a resistance (which might be a resistor, lamp, motor, integrated circuit, etc.), and wiring paths between them and back. **You must be careful not to create "short circuits" (very low-resistance paths across the batteries, see examples below) as this will damage components and/or quickly drain your batteries.** Only connect the IC's using configurations given in the projects, incorrectly doing so may damage them. **Elenco® is not responsible for parts damaged due to incorrect wiring.**

Here are some important guidelines:

- ALWAYS** USE EYE PROTECTION WHEN EXPERIMENTING ON YOUR OWN.
- ALWAYS** include at least one component that will limit the current through a circuit, such as the speaker, lamp, whistle chip, capacitors, IC's (which must be connected properly), motor, microphone, photoresistor, or fixed resistors.
- ALWAYS** use the **7-segment display**, LED's, transistors, the high frequency IC, the **SCR**, the antenna, and switches **in conjunction with other components that will limit the current through them**. Failure to do so will create a short circuit and/or damage those parts.
- ALWAYS** connect the adjustable resistor so that if set to its 0 setting, the current will be limited by other components in the circuit.
- ALWAYS** connect position capacitors so that the "+" side gets the higher voltage.
- ALWAYS** disconnect your batteries immediately and check your wiring if something appears to be getting hot.
- ALWAYS** check your wiring before turning on a circuit.
- ALWAYS** connect **IC's**, the **FM module**, and the **SCR** using configurations given in the projects or as per the connection descriptions for the parts.
- NEVER** try to use the high frequency IC as a transistor (the packages are similar, but the parts are different).
- NEVER** use the 2.5V lamp in a circuit with both battery holders unless you are sure that the voltage across it will be limited.
- NEVER** connect to an electrical outlet in your home in any way.
- NEVER** leave a circuit unattended when it is turned on.
- NEVER** touch the motor when it is spinning at high speed.

Note: If you have the more advanced Model SC-750, there are additional guidelines in your other project manual.

For all of the projects given in this book, the parts may be arranged in different ways without changing the circuit. For example, the order of parts connected in series or in parallel does not matter — what matters is how combinations of these sub-circuits are arranged together.

Warning to Snap Rover owners: Do not connect your parts to the Rover body except when using our approved circuits, the Rover body has a higher voltage which could damage your parts.

Examples of SHORT CIRCUITS - NEVER DO THESE!!!

Placing a 3-snap wire directly across the batteries is a SHORT CIRCUIT.

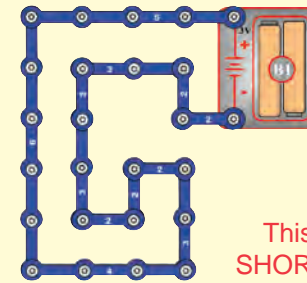
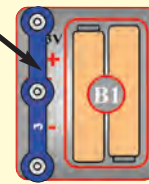

This is also a SHORT CIRCUIT.

When the slide switch (S1) is turned on, this large circuit has a SHORT CIRCUIT path (as shown by the arrows). The short circuit prevents any other portions of the circuit from ever working.

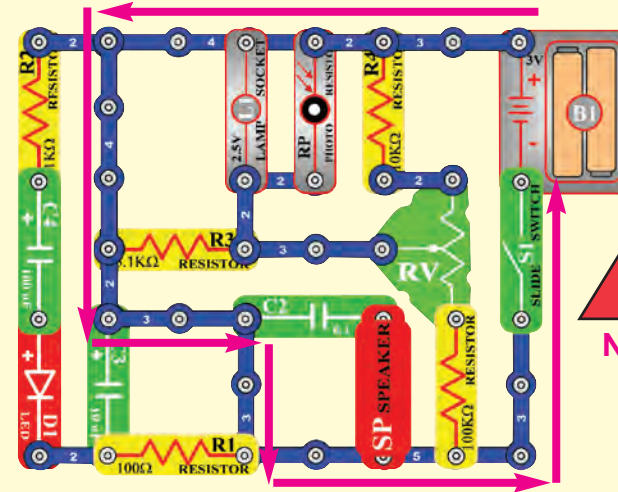

You are encouraged to tell us about new circuits you create. If they are unique, we will post them with your name and state on our website at www.snapcircuits.net/kidkreations.htm. Send your suggestions to Elenco®.

Elenco® provides a circuit designer so that you can make your own Snap Circuits® drawings. This Microsoft® Word document can be downloaded from www.snapcircuits.net/SnapDesigner.doc or through the www.snapcircuits.net web site.



WARNING: SHOCK HAZARD - Never connect Snap Circuits® to the electrical outlets in your home in any way!

Project Listings

Project #	Description	Page #	Project #	Description	Page #	Project #	Description	Page #
306	AM Radio	8	340	Music Meter	18	374	Display Letter "e"	28
307	Adjustable Volume FM Radio	8	341	LED & Relay	19	375	Display Letter "h"	28
308	Playback & Record	9	342	Manual 7 Second Timer	19	376	Recorded Voice Transmitter	28
309	Playing Music	9	343	Half Wave Rectifier Circuit	20	377	Space War Alarm by SCR	29
310	Light-Controlled Music	9	344	Half Wave Rectifier Circuit (II)	20	378	Light Space War Alarm	29
311	Touch-Controlled Music	9	345	LED vs. Diode	20	379	Alarm by SCR	29
312	Power Playback & Record	10	346	Current & Resistance	20	380	Light & Alarm IC	29
313	Power Amplified Playing Music	10	347	Telegraph	21	381	Delay Light	30
314	Power Light-Controlled Music	10	348	Mosquito Sound	21	382	Delay Fan	30
315	Power Touch-Controlled Music	10	349	Mosquito Sound (II)	21	383	Sound Activated Fan	30
316	FM Radio	11	350	Mosquito Sound (III)	21	384	Recording LED Indicator	31
317	Mega Circuit	11	351	Touch-Control Mosquito Sound	21	385	Playback & Record with Meter	31
318	SCR 2.5V Bulb	12	352	Bulb & Relay	22	386	Alarm Light	32
319	SCR & Motor	12	353	Relay Buzzer	22	387	Alarm Light (II)	32
320	Music Alarm	13	354	Transistor Timer	23	388	Night Police Car	33
321	Light-Music Alarm	13	355	Light-Controlled Relay	23	389	Night Machine Gun	33
322	Light-Controlled SCR	13	356	Bulb Alert Relay	23	390	Night Fire Engine	33
323	3mA Meter	14	357	Adjustable Light Control	24	391	Night Ambulance	33
324	0-3V Meter	14	358	Meter Deflection	24	392	Daytime Light Police Car	34
325	Function of adjustable resistor	15	359	AC to DC Current	25	393	Daytime Light Machine Gun	34
326	Function of Photoresistor	15	360	Current Meter	25	394	Daytime Light Fire Engine	34
327	Meter Deflect by Motor	16	361	Buzzer, Relay, & Transformer	26	395	Daytime Light Ambulance	34
328	SCR 6V Bulb	16	362	Buzzer & Relay	26	396	Flashing 8	35
329	Principle of Segment LED	17	363	Display Capital Letter "F"	27	397	Flashing 8 with Sound	35
330	Display #1	17	364	Display Capital Letter "H"	27	398	Musical Space War	35
331	Display #2	17	365	Display Capital Letter "P"	27	399	Electronic Noisemaker	36
332	Display #3	17	366	Display Capital Letter "S"	27	400	Electronic Noisemaker (II)	36
333	Display #4	17	367	Display Capital Letter "U"	27	401	Bee	36
334	Display #5	18	368	Display Capital Letter "C"	27	402	Bee (II)	36
335	Display #6	18	369	Display Capital Letter "E"	27	403	Bee (III)	36
336	Display #7	18	370	Display "."	27	404	Oscillator Sound	37
337	Display #8	18	371	Display Letter "b"	28	405	Oscillator Sound (II)	37
338	Display #9	18	372	Display Letter "c"	28	406	Oscillator Sound (III)	37
339	Display #0	18	373	Display Letter "d"	28	407	Oscillator Sound (IV)	37

Project Listings

Project #	Description	Page #	Project #	Description	Page #	Project #	Description	Page #
408	Oscillator Sound (V)	37	443	Flashing "A & J"	46	478	Variable Oscillator (II)	53
409	Transistor Tester	38	444	Alarm Timer	46	479	Variable Oscillator (III)	53
410	Adjustable Voltage Divider	38	445	Alarm Timer (II)	46	480	Variable Oscillator (IV)	53
411	Automatic Display Capital Letter "C"	39	446	Alarm Timer (III)	46	481	Photo Variable Resistor	53
412	Automatic Display Capital Letter "E"	39	447	Bird Sounds	47	482	Variable Whistle Chip Oscillator	53
413	Automatic Display Capital Letter "F"	39	448	Bird Sounds (II)	47	483	Slow Adjusting Tone	53
414	Automatic Display Capital Letter "H"	39	449	Bird Sounds (III)	47	484	Slow Adjusting Tone (II)	53
415	Automatic Display Capital Letter "P"	39	450	Bird Sounds (IV)	47	485	Fixed-Current Path	54
416	Automatic Display Capital Letter "S"	39	451	Bird Sounds (V)	47	486	Simple Illumination Meter	54
417	Automatic Display Capital Letter "U"	39	452	Touch-Control Bird Sound	47	487	LED Voltage Drop	55
418	Automatic Display Capital Letter "L"	39	453	Motor Sound Recording	48	488	Open/Closed Door Indicator	55
419	Whistle Chip Sounds	40	454	Motor Sound Indicator	48	489	Hand-Control Meter	56
420	Whistle Chip Sounds (II)	40	455	Relay & Buzzer	49	490	Light-Control Meter	56
421	Whistle Chip Sounds (III)	40	456	Relay & Speaker	49	491	Electric-Control Meter	56
422	Whistle Chip Sounds (IV)	40	457	Electronic Playground	49	492	Sound-Control Meter	56
423	Whistle Chip Sounds (V)	40	458	Electronic Cat	50	493	Fixed-Voltage Divider	57
424	Whistle Chip Sounds (VI)	40	459	Electronic Cat (II)	50	494	Resistor Measurement	57
425	LED Music	41	460	Electronic Cat (III)	50	495	Automatic Display Letter "b"	58
426	Light-Controlled LED Time Delay	41	461	Electronic Cat (IV)	50	496	Automatic Display Letter "c"	58
427	Touch-Controlled LED Time Delay	41	462	Buzzer Cat	50	497	Automatic Display Letter "d"	58
428	Alarm Recorder	42	463	Buzzer Cat (II)	50	498	Automatic Display Letter "e"	58
429	Alarm Recorder (II)	42	464	Buzzer Cat (III)	50	499	Automatic Display Letter "h"	58
430	Machine Gun Recorder	42	465	Lazy Cat	50	500	Automatic Display Letter "o"	58
431	Time Delay 1-7 Seconds	43	466	Meter Deflection (II)	51	501	Hand-Control Display 1 & 4	59
432	Time Delay	43	467	Automatic Display #1	51	502	Hand-Control Display 1 & 0	59
433	Manual 7 Second Timer (II)	44	468	Automatic Display #2	51	503	Hand-Control Display 1 & 7	59
434	15 Second Alarm	44	469	Automatic Display #3	52	504	Hand-Control Display 1 & 8	59
435	Flashing "1 & 2"	45	470	Automatic Display #4	52	505	Hand-Control Display 1 & 9	59
436	Flashing "3 & 4"	45	471	Automatic Display #5	52	506	Monitor Capacitor Charging & Discharging	60
437	Flashing "5 & 6"	45	472	Automatic Display #6	52	507	Hand-Control Space Meter	60
438	Flashing "7 & 8"	45	473	Automatic Display #7	52	508	Rhythm Swinging Meter	61
439	Flashing "9 & 0"	45	474	Automatic Display #8	52	509	Police Car Sound with Whistle Chip	61
440	Flashing "b & c"	46	475	Automatic Display #9	52	510	Fire Engine Sound with Whistle Chip	61
441	Flashing "d & e"	46	476	Automatic Display #0	52	511	Ambulance Sound with Whistle Chip	61
442	Flashing "h & o"	46	477	Variable Oscillator	53			



Project #306

AM Radio

OBJECTIVE: To build a one-IC AM radio.

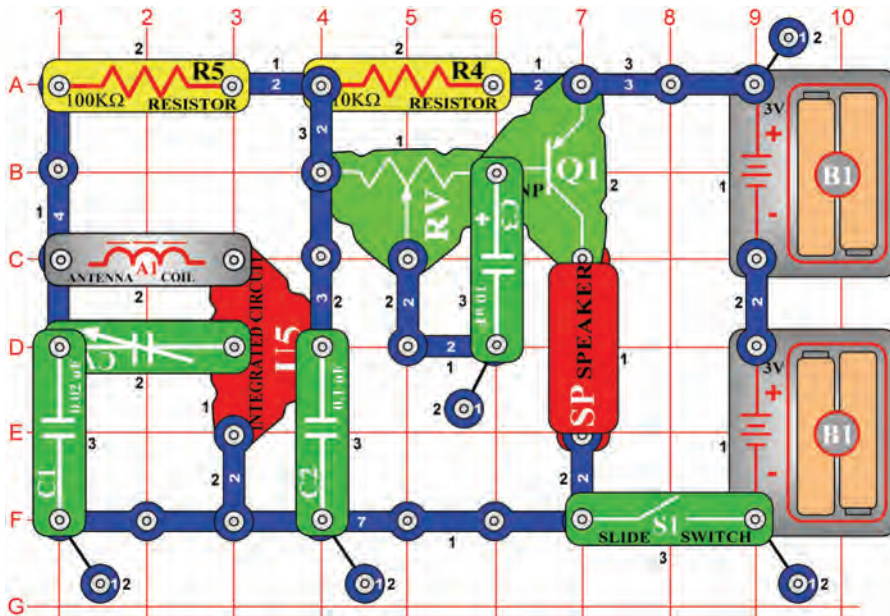

Turn on the slide switch (S1) and adjust the variable capacitor (CV) for a radio station. Make sure you set the variable resistor (RV) control to the left for louder sound.



Project #307

Adjustable Volume FM Radio

OBJECTIVE: To build a working FM radio with adjustable volume.

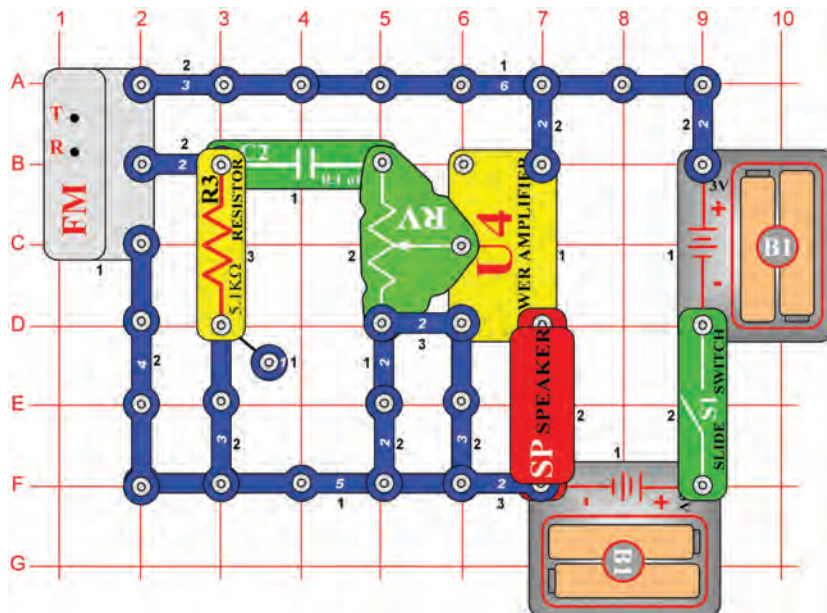

Turn on the slide switch (S1) and press the R button. Now press the T button and FM module (FM) scans for a radio station. When a station is found, it locks on to it and you hear it on the speaker (SP). Adjust the volume using the adjustable resistor (RV). The resistor controls the amount of signal into the power amplifier IC (U4). Press the T button again for the next radio station. The module will scan up to 108MHz, the end of the FM band, and stop. You must then press reset (R) to start at 88MHz again.



Project #308

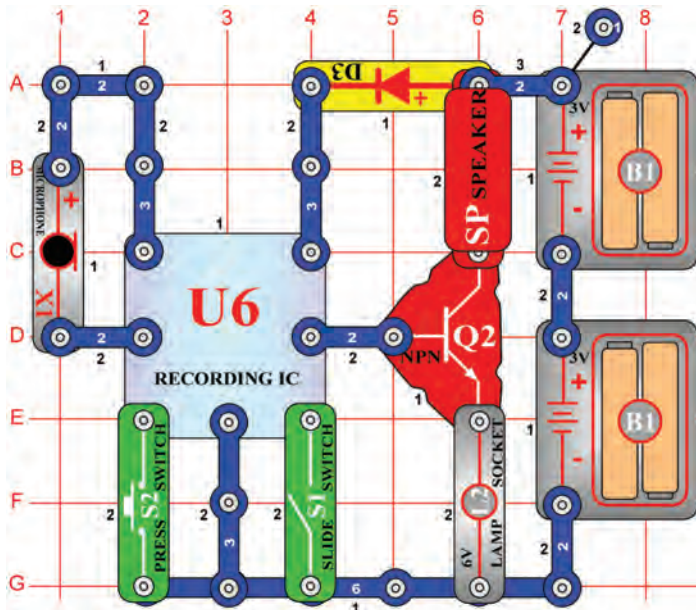

Playback & Record

OBJECTIVE: To demonstrate the capabilities of the recording integrated circuit.

Build the circuit shown. Turn on the slide switch (S1), you hear a beep signaling that you may begin recording. Talk into the microphone (X1) up to 5 seconds, and then turn off the slide switch (it also beeps after the 5 seconds expires).

Press the press switch (S2) for playback. It plays the recording you made followed by one of three songs. If you press the press switch before the song is over, music will stop. You may press the press switch several times to play all three songs. The lamp (L2) is used to limit current and will not light.



Project #309 Playing Music

OBJECTIVE: To play the three built-in songs on the recording IC.

Use the circuit in project #308. Turn on the slide switch (S1), then press the press switch (S2) to start the first song. When the music stops, press the press switch again to hear the second song. When the second song stops, press the press switch again, the third song plays.



Project #310 Light- Controlled Music

OBJECTIVE: To build a circuit that uses light to control the recording IC.

Use the circuit in project #308. Replace the press switch (S2) with the photoresistor (RP), then turn on the slide switch (S1). Turn the music on and off by waving your hand over photoresistor.



Project #311 Touch- Controlled Music

OBJECTIVE: To build a circuit that lets you control the recording IC with your fingers.

Use the circuit in project #308. Place a single snap on base grid point F1. Replace the press switch (S2) with the PNP transistor (Q1, with the arrow on point E2) and then turn on the slide switch (S1). Turn the music on and off by touching points F1 & G2 at the same time. You may need to wet your fingers.



Project #312

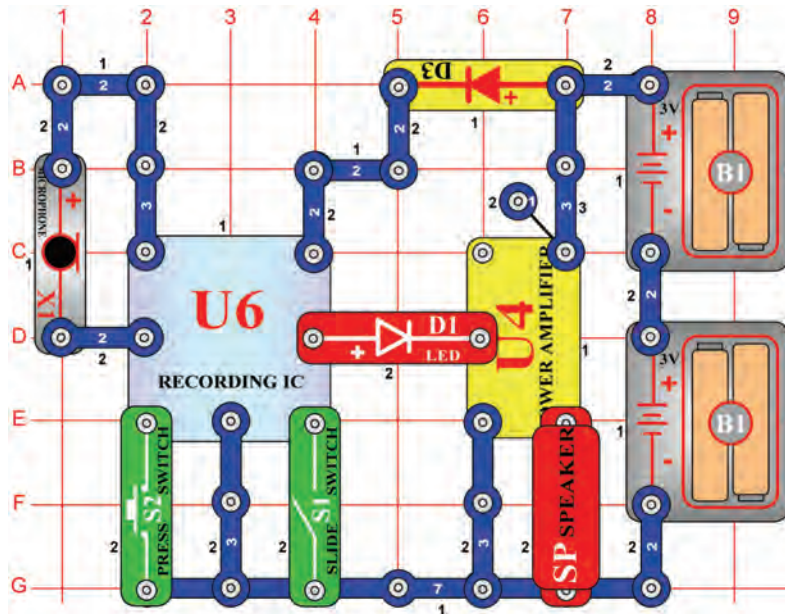

Power Playback & Record

OBJECTIVE: To build a circuit that amplifies the recording IC.

Connecting the power amplifier IC (U4) to the output of the recording IC (U6), you can make much louder music than project #308.

Turn on the switch (S1), you hear a beep signaling that you may begin recording. Talk into the microphone up to 5 seconds, and then turn open the switch (it also beeps after the 5 seconds expires).

Press the press switch (S2) for playback. It plays the recording you made followed by one of three songs. If you press switch (S2) before the song is over, music will stop. You may press the press switch several times to play all three songs.



Project #313 Power Amplified Playing Music

OBJECTIVE: To amplify the output of the recording IC.

Use the circuit in project #312. Turn on the switch (S1), then press the press switch (S2) to start the first song. When the music stops, press the press switch again to hear the second song. When the second song stops, press the press switch again, the third song plays.



Project #314 Power Light- Controlled Music

OBJECTIVE: Show variations of project #312.

Use the circuit in project #312. Replace the press switch (S2) with the photoresistor (RP), then turn on the switch (S1). Turn the music on and off by waving your hand over photoresistor.



Project #315 Power Touch- Controlled Music

OBJECTIVE: Show variations of project #312.

Use the circuit in project #312. Place a single snap on base grid point F1. Replace the press switch (S2) with the PNP transistor (Q1, with the arrow on point E2) and then turn on the slide switch (S1). Turn the music on and off by touching points F1 & G2 at the same time. You may need to wet your fingers.



Project #316

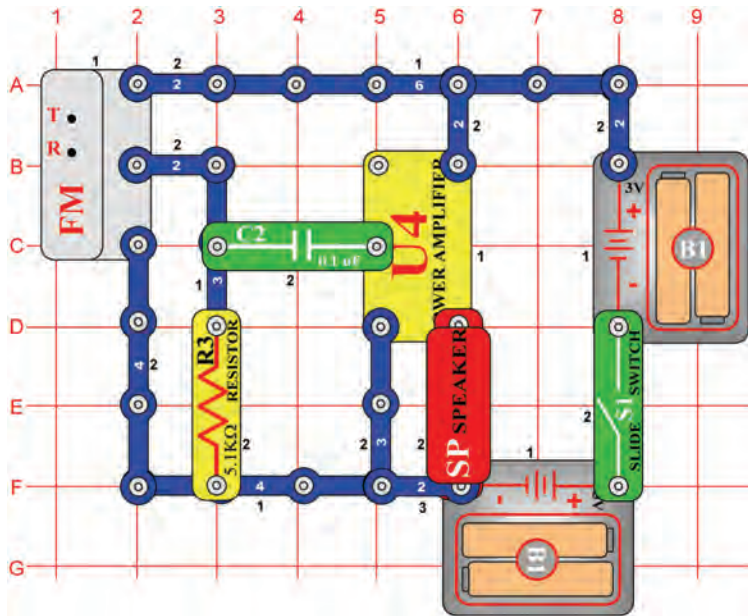

FM Radio

OBJECTIVE: To build a working FM radio.

The FM module (FM) contains a scan (T) and a reset (R) button. The R button resets the frequency to 88MHz. This is the beginning of the FM range. Press the T button, the module scans for the next available radio station.

Turn on the slide switch (S1) and press the R button. Now press the T button and the FM module scans for an available radio station. When a station is found, it locks on to it and you hear it on the speaker. Press the T button again for the next radio station. The module will scan up to 108MHz, the end of the FM band, and stop. You must then press the reset (R) button to start at 88MHz again.



Project #317

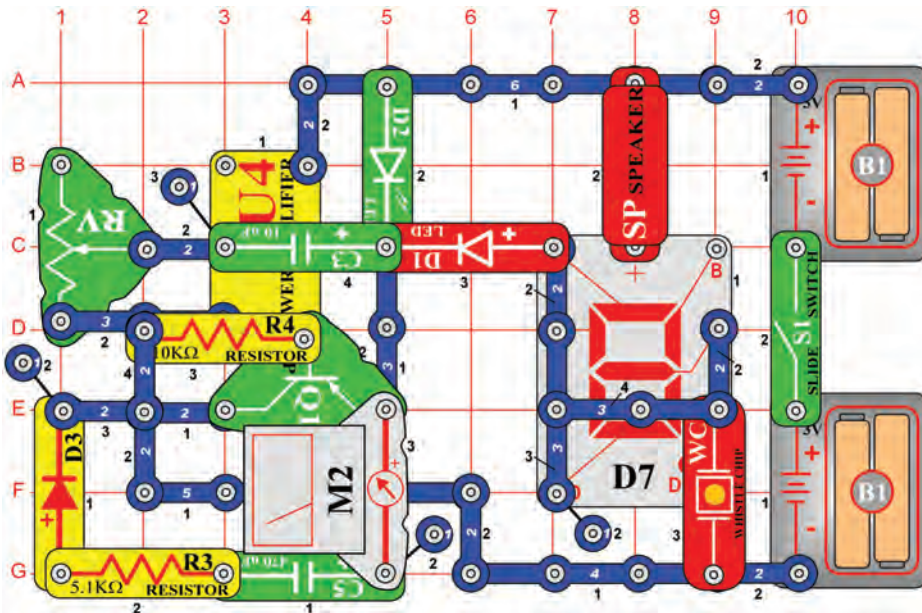

Mega Circuit

OBJECTIVE: To build a complex circuit.

Note that there is a 3-snap wire between RV and U4, partially hidden under R4.

This is an example of using many parts to create an unusual circuit. Set the meter (M2) to the LOW (or 10mA) scale. Turn on the slide switch (S1). As the circuit oscillates, the 7-segment display (D7) flashes the number 5 and the LED's (D1 & D2) flash as well. The meter deflects back and forth and the speaker (SP) sounds a low tone at the same rate. The frequency of the circuit can be changed by adjusting the adjustable resistor (RV).

Next, place the 100Ω resistor (R1) directly over the diode (D3) using a 1-snap. See how this changes the circuit performance.



Project #318

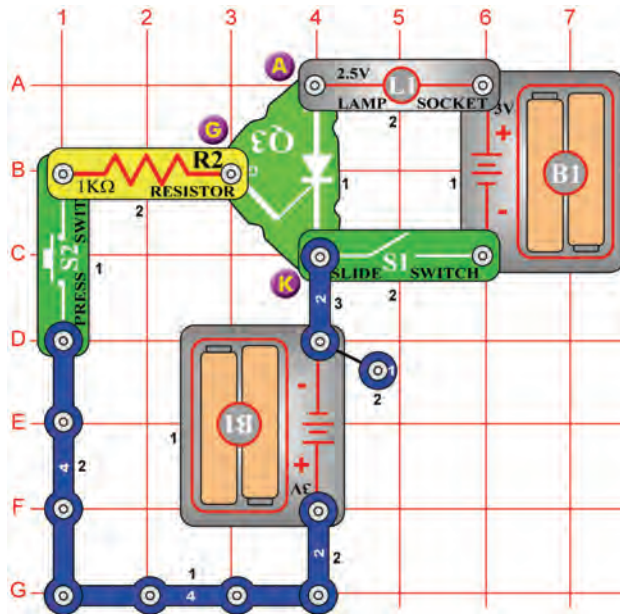

SCR 2.5V Bulb

OBJECTIVE: To learn the principle of an SCR.

This circuit demonstrates the principle of the SCR (Q3). The SCR can be thought of as an electronic switch with three leads: anode, cathode, and gate. Like a standard diode, it permits current flow in only one direction. It will only conduct in the forward direction when triggered by a short pulse or steady voltage applied between the gate and cathode terminals. One set of batteries powers the lamp, the other is used to trigger the SCR.

Turn on the slide switch (S1) and the bulb (L1) should not light. Now press the press switch (S2); the SCR turns on and lights the bulb. To turn off the bulb you must turn off the slide switch (S1).



Project #319

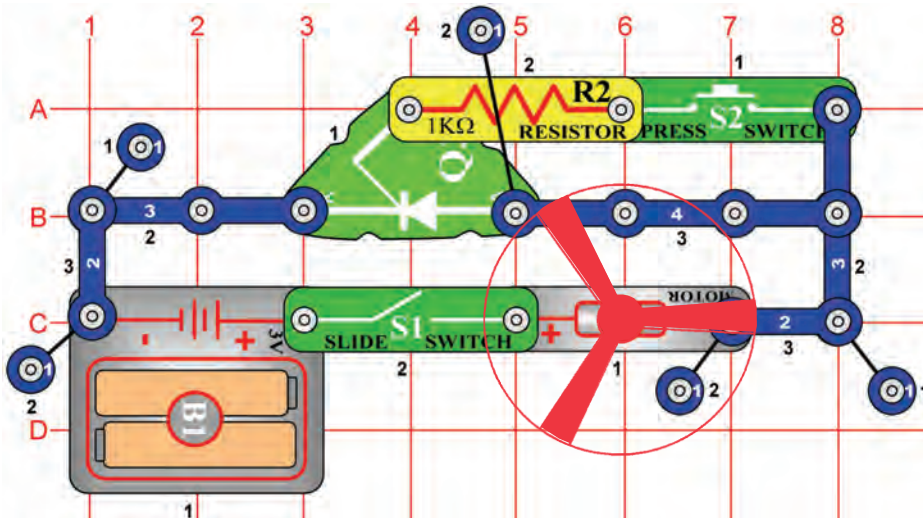

SCR & Motor

OBJECTIVE: To activate a motor using an SCR.

Place the fan onto the motor (M1). In this circuit, the gate is connected to the battery (B1) through the 1KΩ resistor (R2). When the slide switch (S1) is turned on, it triggers the gate, the SCR (Q3) conducts, and the motor spins. The motor continues to spin until the switch is turned off.



WARNING: Moving parts. Do not touch the fan or motor during operation. Do not lean over the motor.



Project #320

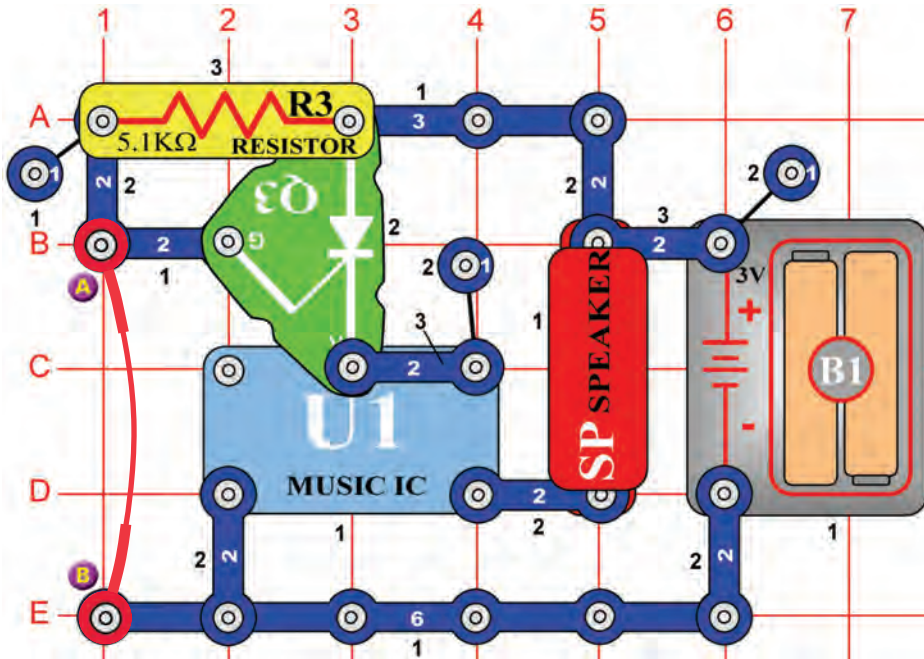

Music Alarm

OBJECTIVE: To build a music alarm.

The alarm circuit activates when you remove the jumper wire from points A & B. The jumper wire shorts the SCR's (Q3) gate to ground and the SCR does not conduct. Removing the jumper wire places a voltage on the gate and the SCR conducts. This connects the battery to the music IC (U1) and music is played.

Construct the circuit and you should hear no music. Now remove the jumper wire and the music starts playing.



Project #321 Light-Music Alarm

OBJECTIVE: To build a light-music alarm.

Use the circuit in project #320. Replace the resistor R3 with the photoresistor (RP) and remove the jumper wire. Cover the photoresistor with your hand. Now slowly remove your hand. When enough light hits the resistor, the music plays.



Project #322

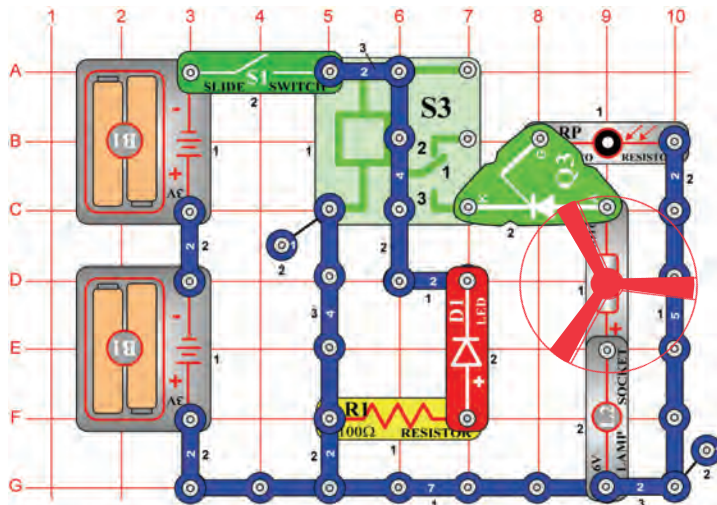

Light-controlled SCR

OBJECTIVE: To build a circuit that activates a bulb and motor with the amount of light present.

Cover the photoresistor (RP) with your finger. Turn on the switch (S1), and only the LED (D1) lights. The relay (S3) connects the motor (M1) and the bulb (L2) to the batteries, but the motor and bulb are powerless until a voltage is applied to the SCR's gate.

Remove your finger, as light hits the photoresistor, its resistance decreases and a voltage appears on the gate of the SCR (Q3). The SCR conducts and the motor and bulb work now.

WARNING: Moving parts. Do not touch the fan or motor during operation. Do not lean over the motor.



Project #323

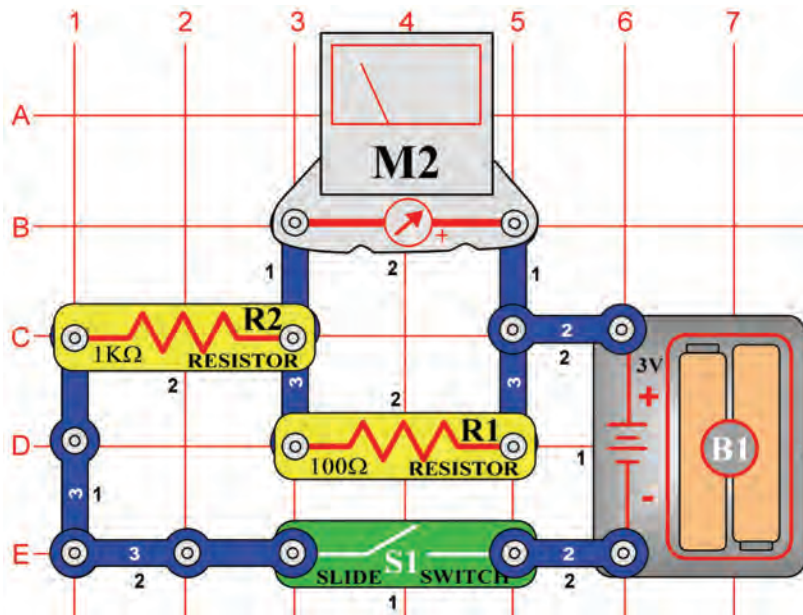

3mA Meter

OBJECTIVE: To build a 3mA meter circuit.

Set the meter (M2) to the LOW (or 10mA) scale. Inside the meter, there is a fixed magnet and a moveable coil around it. As current flows through the coil, it creates a magnetic field. The interaction of the two magnetic fields cause the coil (connected to the pointer) to move (deflect). By itself, the meter can measure $300\mu\text{A}$. To increase its range, resistors are connected in parallel or in series to the meter.

Build the circuit shown. Placing the 100Ω resistor (R1) in parallel with the meter increases the range by 10 times to 3mA. More current flows through the resistor than the meter. The lower the resistor value, the wider the range of the meter.



Project #324

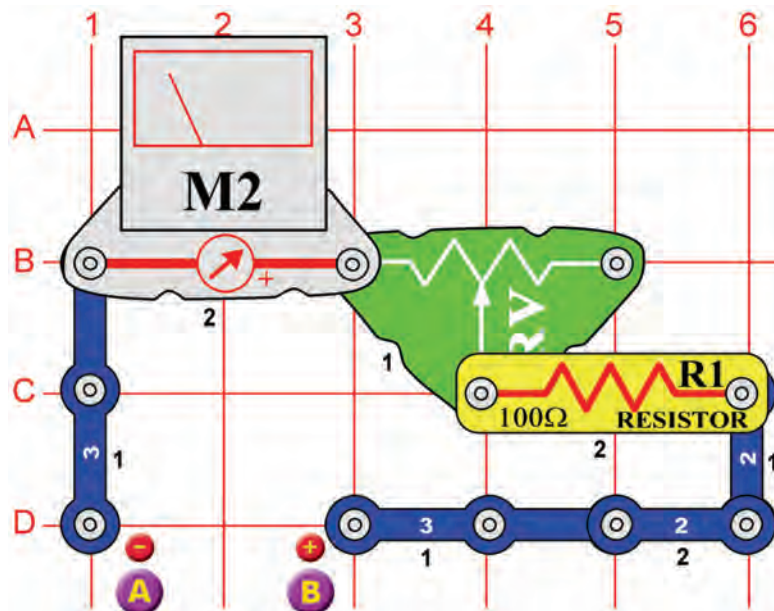

0-3V Voltmeter

OBJECTIVE: To build a voltmeter.

Build this 0-3V voltmeter circuit. Set the meter (M2) to the LOW (or 10mA) setting. Using new batteries, place the battery holder between points A & B. Adjust the adjustable resistor (RV) so the meter deflects full scale.

Now you can check your other "AA" batteries by inserting them into the battery holder.



Project #325

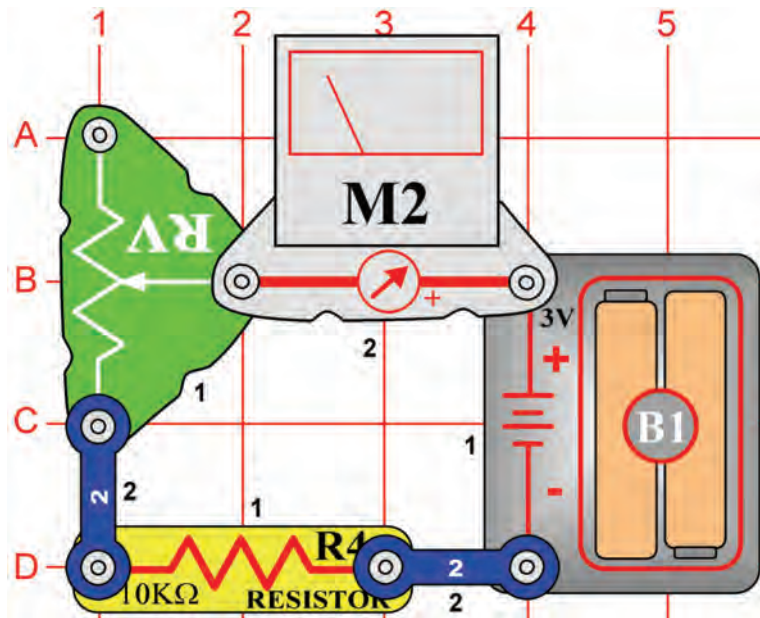

Function of Adjustable Resistor

OBJECTIVE: To understand the function of the adjustable resistor.

An adjustable resistor is a normal resistor with an additional arm contact. The arm moves along the resistive material and taps off the desired resistance.

The slider on the adjustable resistor moves the arm contact and sets the resistance between the bottom (point C1) pin and the center pin (point B2). The remaining resistance is between the center and top pin. For example, when the slider is all the way down, there is minimal resistance between the bottom and center pins (usually 0Ω) and maximum resistance between the center and top pins. The resistance between the top (point A1) and bottom (point A3) pins will always be the total resistance, ($50k\Omega$ for your part).

Set the meter (M2) to the LOW (or 10mA) scale. Adjust the adjustable resistor (RV) for maximum resistance by setting the slider to the top. The meter only deflects part of the way. As you move the slider down, decreasing the resistance, the meter deflects more.



Project #326

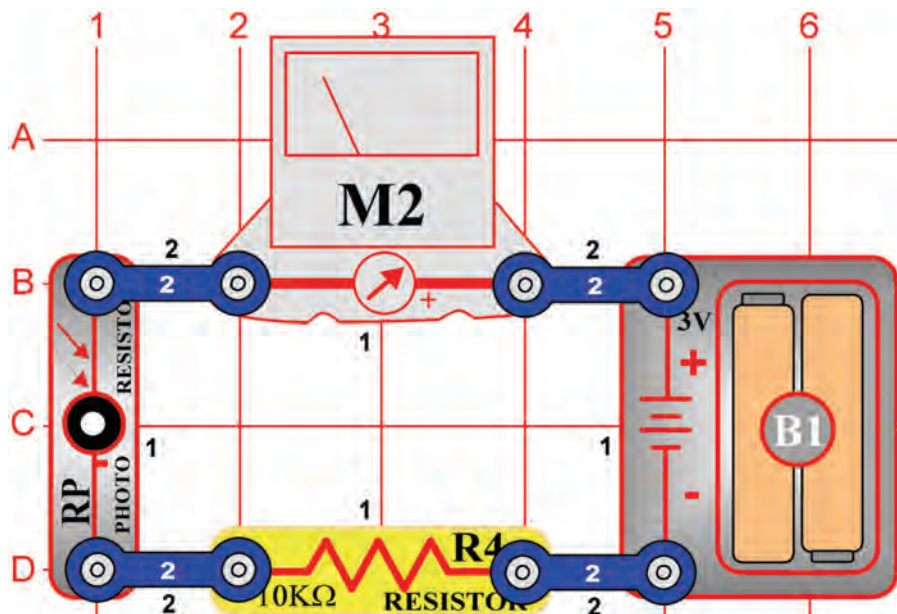

Function of photoresistor

OBJECTIVE: To understand the function of the photoresistor.

Build the circuit shown. Set the meter (M2) to the LOW (or 10mA) scale. The photoresistor (RP) is a light-sensitive resistor. Its value changes from nearly infinite in total darkness to about $1,000\Omega$ when a bright light shines on it.

The meter reading changes as the resistance changes in the circuit. When the lights are on, the meter points to a higher number on the scale. When the lights are OFF, the pointer will point to a lower number on the scale. This means that the resistance of the photoresistor is changing according to the amount of light in the room.



Project #327

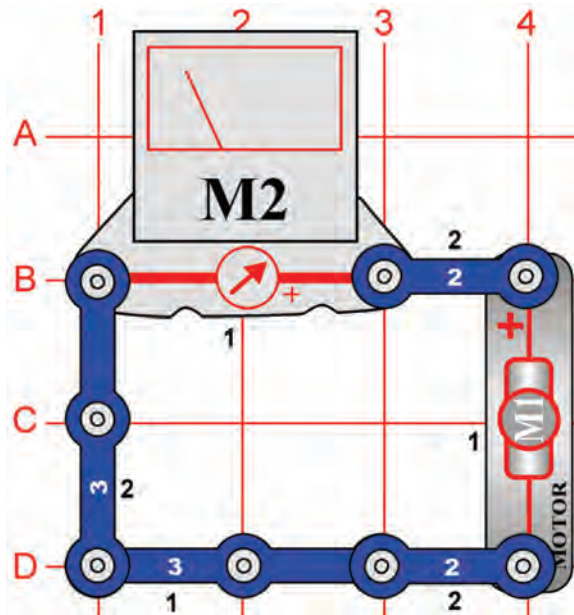

Meter Deflect by Motor

OBJECTIVE: To change the direction of current flow using a motor.

Set the meter (M2) to the LOW (or 10mA) setting. A motor generates a current when it rotates. The rotation of the motor determines the direction current flows. Quickly spin the motor (M1) clockwise with your hand; the meter deflects to the right. Now spin the motor counterclockwise, and the meter deflects to the left.



Project #328

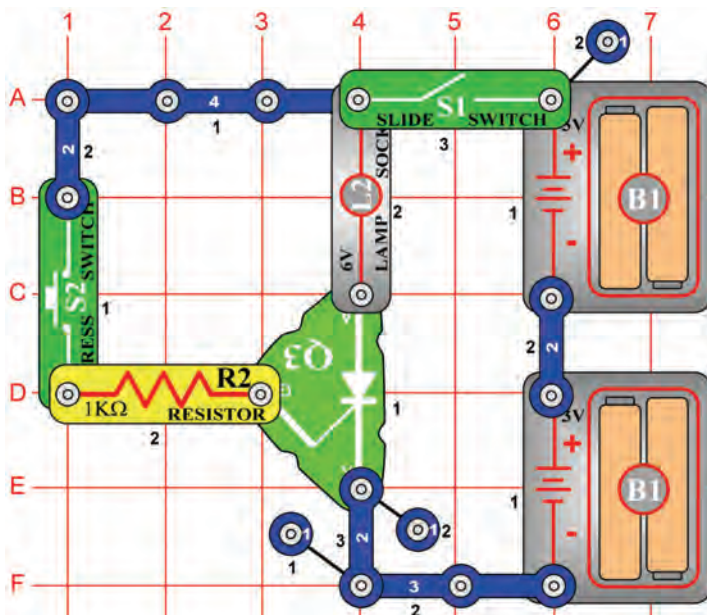

SCR 6V Bulb

OBJECTIVE: To learn the principle of an SCR.

In this circuit, the 6-volt bulb (L2) will not light until the SCR (Q3) is triggered. Turn on the slide switch (S1) and the bulb will not light. Now press the press switch (S2) to light the bulb. The bulb will stay lit until the slide switch is turned off. To protect the SCR, a current limiting 1kΩ resistor (R2) is placed in series with the gate.



Project #329

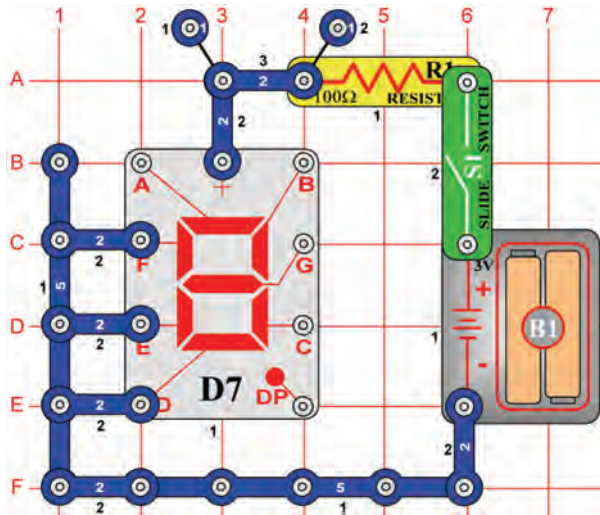

Principle of Segment LED

OBJECTIVE: To demonstrate how a seven segment LED works.

The display (D7) is made up of seven segments. Each segment contains an LED connected to an input snap. When the snap is connected to the negative of the battery the segment lights. For example, connect the circuit as shown and the letter "L" lights.

Project #330 Display #1

OBJECTIVE: To configure the seven segment to display the number 1.

Connect B & C to the negative of the battery.

Project #331 Display #2

OBJECTIVE: To configure the seven segment to display the number 2.

Connect A, B, G, E, & D to the negative of the battery.

Project #332 Display #3

OBJECTIVE: To configure the seven segment to display the number 3.

Connect A, B, G, C, & D to the negative of the battery.

Project #333 Display #4

OBJECTIVE: To configure the seven segment to display the number 4.

Connect B, C, F, & G to the negative of the battery.

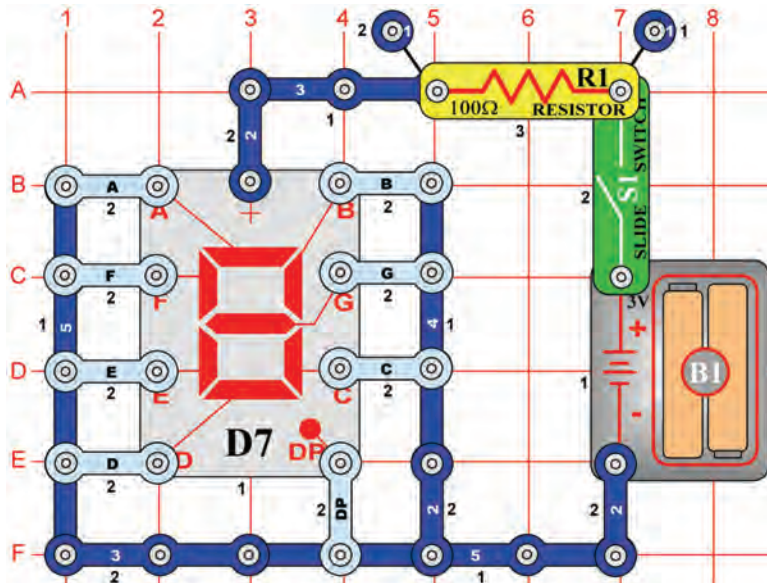

Project #334 Display #5

OBJECTIVE: To configure the seven segment to display the number 5.

Connect A, F, G, C, & D to the negative of the battery.

Project #335 Display #6

OBJECTIVE: To configure the seven segment to display the number 6.

Connect A, C, D, E, F, & G to the negative of the battery.

Project #336 Display #7

OBJECTIVE: To configure the seven segment to display the number 7.

Connect A, B, & C to the negative of the battery.

Project #337 Display #8

OBJECTIVE: To configure the seven segment to display the number 8.

Connect A, B, C, D, E, F & G to the negative of the battery.

Project #338 Display #9

OBJECTIVE: To configure the seven segment to display the number 9.

Connect A, B, C, D, F, & G to the negative of the battery.

Project #339 Display #0

OBJECTIVE: To configure the seven segment to display the number 0.

Connect A, B, C, D, E, & F to the negative of the battery.

Project #340

Music Meter

OBJECTIVE: See and hear the output of the music IC.

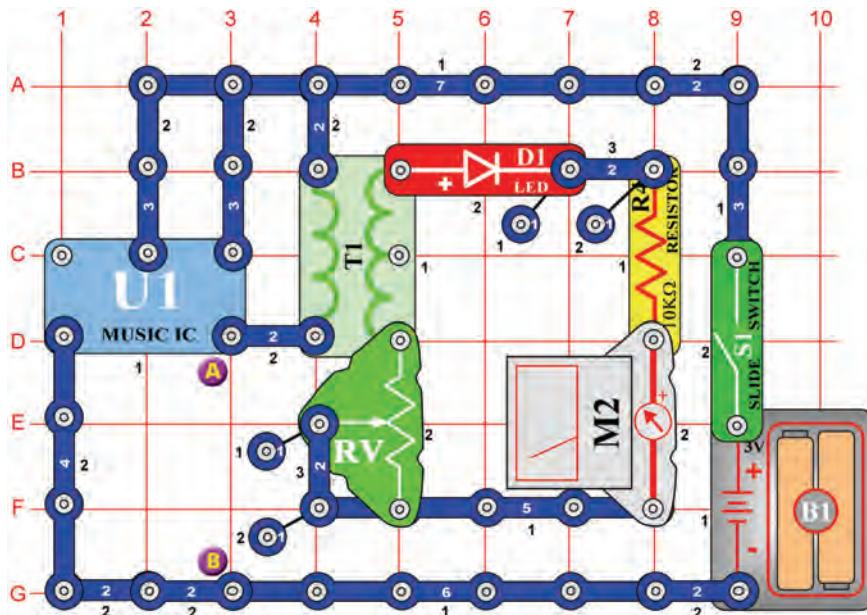

Set the meter (M2) to the LOW (or 10mA) setting. In this circuit, the output of the music IC (U1) is applied to the less windings side of the transformer (T1), which lights the LED (D1) and deflects the meter.

Place the adjustable resistor (RV) to the bottom position and turn on the switch (S1). Adjust the adjustable resistor upwards. This increases the voltage across the LED and meter. The LED brightens and the meter deflects more towards 10. Place the speaker (SP) across points A & B and use a jumper wire to complete the connection. Now you can hear and see the output of the music IC.



Project #341

LED & Relay

OBJECTIVE: Turn on and off LED's using a relay.

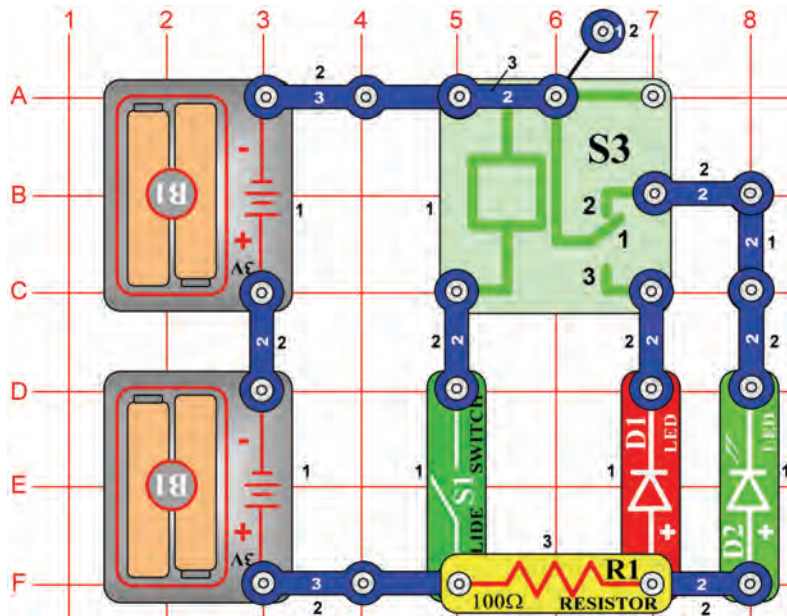

A relay is an electronic switch with contacts that are opened or closed using voltage. It contains a coil that generates a magnetic field when a current flows through it. The magnetic field attracts an iron armature which switches the contacts. Contact #2 is normally closed, connecting the green LED (D2) and the resistor across the batteries. With the slide switch (S1) turned off, the green LED should light. Now turn on the switch, contact #1 on the relay (S3) will switch to contact #3, lighting the red LED (D1).



Project #342

Manual 7 Second Timer

OBJECTIVE: To build a manual timer using a relay.

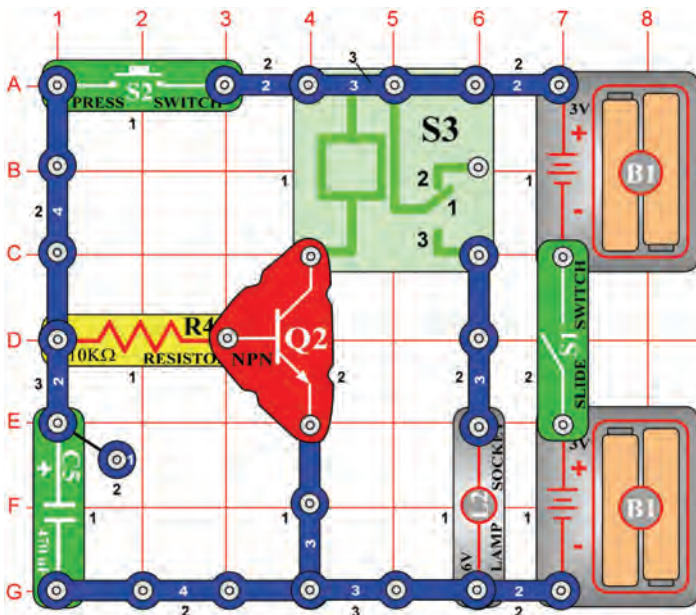

The transistor (Q2) acts as a switch, connecting the relay (S3) to the batteries. As long as there is positive voltage on the transistor's base, the bulb (L2) will light. Turn on the slide switch (S1) and hold down the press switch (S2). The transistor turns on, capacitor C5 charges up, and the bulb lights. When the press switch is released, the capacitor discharges through the base, keeping the transistor on. The transistor will turn off when the capacitor is almost discharged, about 7 seconds. The relay contacts will switch and the bulb will turn off. Change the value of the capacitor and see what happens.



Project #343

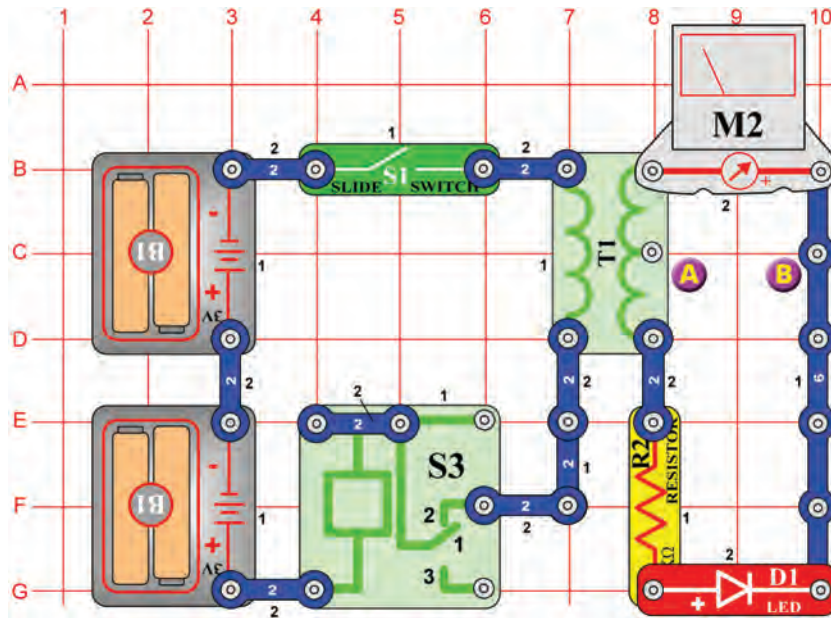

Half Wave Rectifier Circuit

OBJECTIVE: To build a half wave rectifier circuit.

A rectifier changes an AC voltage into a DC voltage. A diode (D1) is used because it allows current to flow in only one direction, for one polarity of applied voltage. As the contacts open and close, it generates an AC voltage across the transformer (T1). We can measure the DC current from the transformer's output using a resistor (R2), a diode (D1), and a meter (M2). Set the meter to the LOW (or 10mA) scale. Turn on the slide switch (S1), the LED lights as the meter points past the 5 scale.



Project #344 Half Wave Rectifier Circuit (II)

OBJECTIVE: Measure the voltage using the center-tap.

Use the circuit in project #343. Now see what happens if you connect to the center-tap on the side with more windings. Place the meter (M2) across points A & B, then turn on the switch (S1). The needle should deflect less, about half as much as project #343. As you use less windings, the output decreases.



Project #345 LED vs. Diode

OBJECTIVE: To see the voltage difference between an LED and diode.

Use the circuit in project #343. Replace the LED (D1) with the diode (D3) and turn on the switch (S1). The needle deflects higher, because the voltage drop across the diode is less than the voltage drop across the LED.



Project #346 Current & Resistance

OBJECTIVE: See how resistance affects current.

Change the 1kΩ (R2) resistor to a 5.1kΩ (R3) and turn on the switch (S1). You will see that increasing the resistance decreases the current through the meter (M2).



Project #347

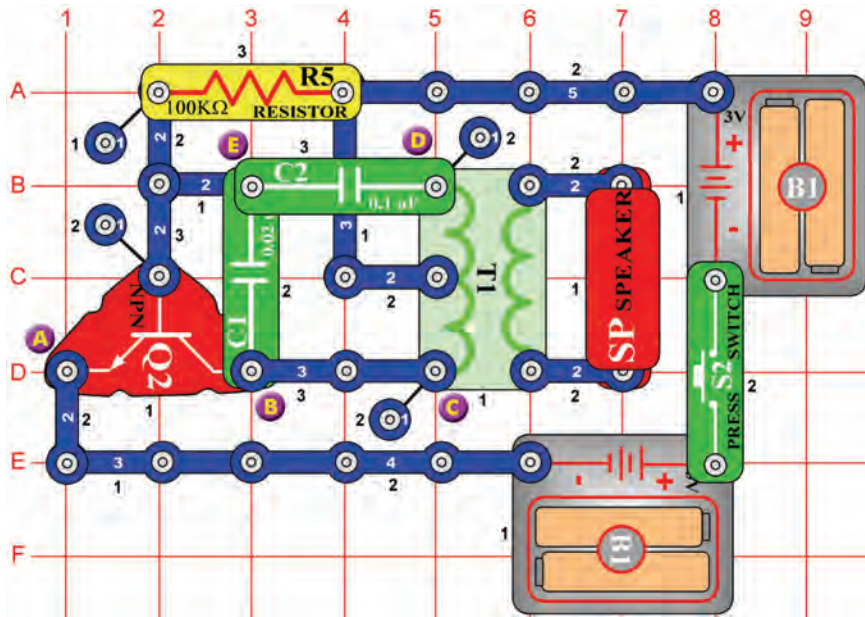

Telegraph

OBJECTIVE: Making telegraph sounds.

Press the press switch (S2) down. The circuit oscillates and the AC voltage generated from the transformer (T1) drives the speaker (SP). To make a telegraph sound, depress the switch for long and short periods.



Project #348 Mosquito Sound

OBJECTIVE: Use the whistle chip to make a mosquito sound.

Use the circuit in project #347. Remove the speaker (SP). Connect the whistle chip (WC) across points C & D to make a mosquito sound.



Project #349 Mosquito Sound (II)

OBJECTIVE: Show variations of project #347.

Use the circuit in project #347. Connect the whistle chip (WC) across points B & E.



Project #350 Mosquito Sound (III)

OBJECTIVE: Show variations of project #347.

Use the circuit in project #347. Connect the whistle chip (WC) across points E & D (place it beneath capacitor (C2) or use the jumper wires).



Project #351 Touch-Control Mosquito Sound

OBJECTIVE: To use the photoresistor to adjust the oscillator sound.

Use the circuit in project #347. Replace the 100kΩ resistor (R5) with the photoresistor (RP). Wave your hand over the resistor and the sound changes.



Project #352

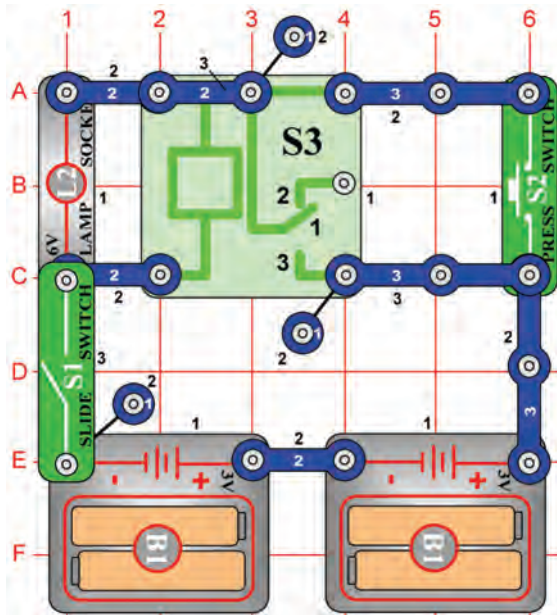

Bulb & Relay

OBJECTIVE: Light a bulb using a relay.

Turn off the slide switch (S1). If you press switch (S2), the lamp (L2) will not light. Turn on the slide switch and press the press switch again; the lamp lights and stays on until the slide switch is turned off. This circuit remembers that the press switch was pressed. Turn the slide switch off and back on again. The lamp will be off until the press switch is pressed, then the lamp will stay on. Computers use memory circuits to remember states like on and off.



Project #353

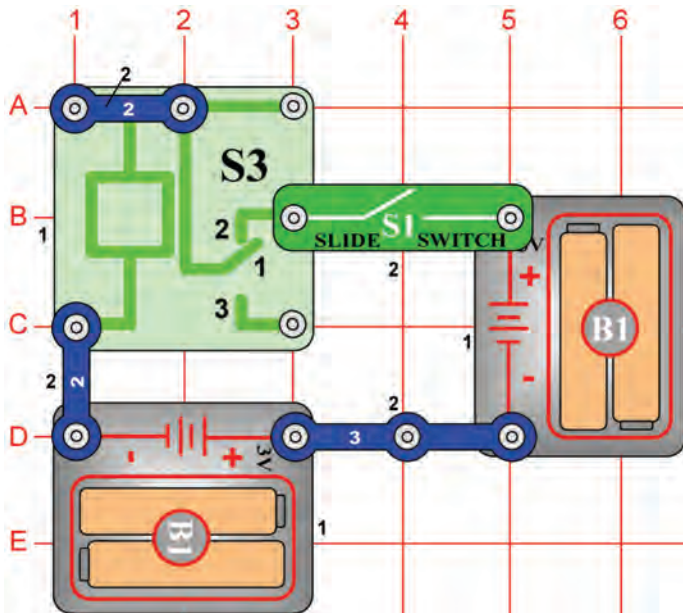

Relay Buzzer

OBJECTIVE: To make a relay buzzer.

When you turn on the switch (S1), you should hear a buzzing sound from the relay (S3). The sound is caused by the relay's contacts opening and closing at a fast rate.



Project #354

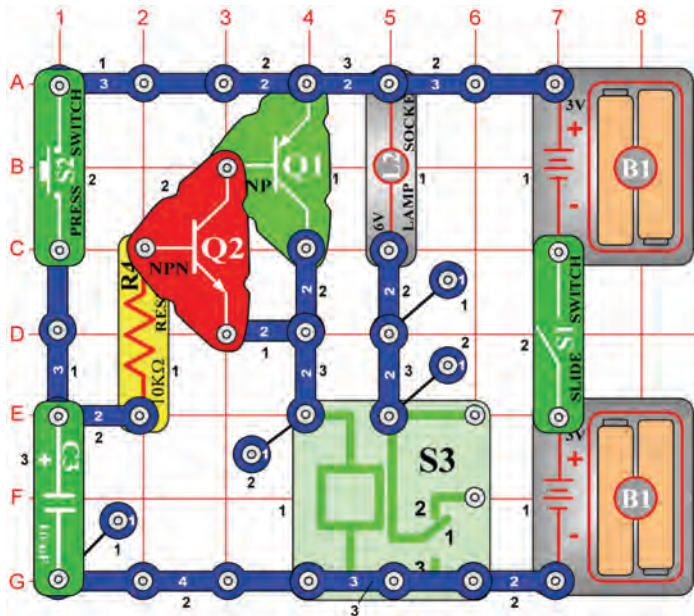

Transistor Timer

OBJECTIVE: To build a manual timer using a transistor in place of the relay.

This circuit is similar to project #342 except now two transistors are used. Turn on the slide switch (S1) and hold down the press switch (S2). The transistors (Q1 & Q2) turn on, the capacitor (C3) charges up, and the bulb (L2) lights. When the press switch (S2) is released, the capacitor discharges through the base, keeping the transistors on. The transistors will turn off when the capacitor is almost discharged (about 1 minute). The relay (S3) contacts will switch and the bulb will turn off.



Project #355

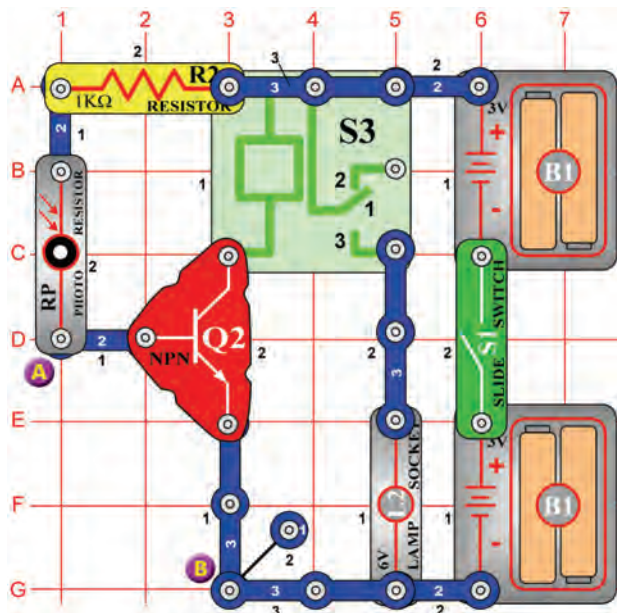

Light-controlled Relay

OBJECTIVE: To use a photoresistor to control a relay.

Under normal light, the resistance of the photoresistor (RP) is low, allowing a voltage at the base of the transistor (Q2). This turns the transistor on, connecting the relay (S3) across the batteries, and the bulb (L2) lights. If the light decreases, the resistance increases and the voltage to Q2 drops. If the voltage at Q2 decreases enough, the transistor turns off.

Turn on the slide switch (S1) and the bulb lights. Now as you block the light from the photoresistor, the bulb turns off.



Project #356 Bulb Alert Relay

OBJECTIVE: Make a warning system that lights the bulb.

Replace the photoresistor (RP) with a 10kΩ resistor (R4). Connect the wire to points A & B. As long as the wire is connected, the transistor (Q2) is off and the relay (S3) and bulb (L2) are not powered. Disconnect the wire. The relay contacts will switch and the bulb will light.



Project #357

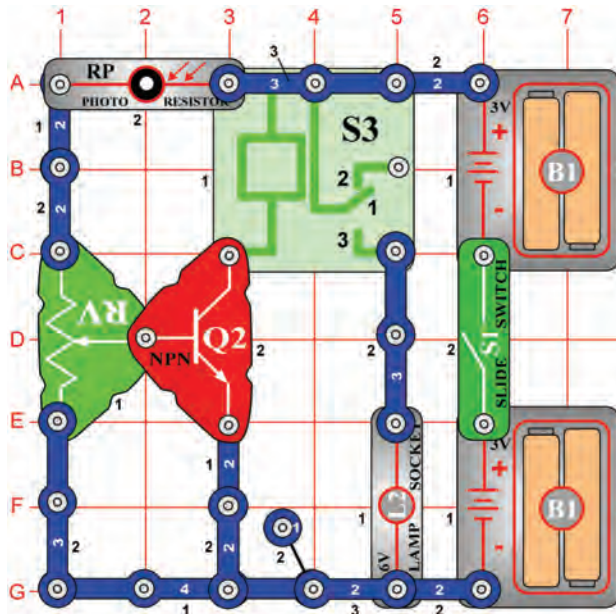

Adjustable Light Control

OBJECTIVE: Build an adjustable light-controlled relay.

You can set the amount of light it takes to keep the bulb (L2) on by adjusting the adjustable resistor (RV). Set the adjustable resistor to the top position and turn on the switch. The bulb lights. Cover the photoresistor (RP) and the bulb turns off. Set the adjustable resistor to different positions and then cover the photoresistor. Note that only the top half of the adjustable resistor affects the circuit. If you position it below the middle, the bulb stays off.



Project #358

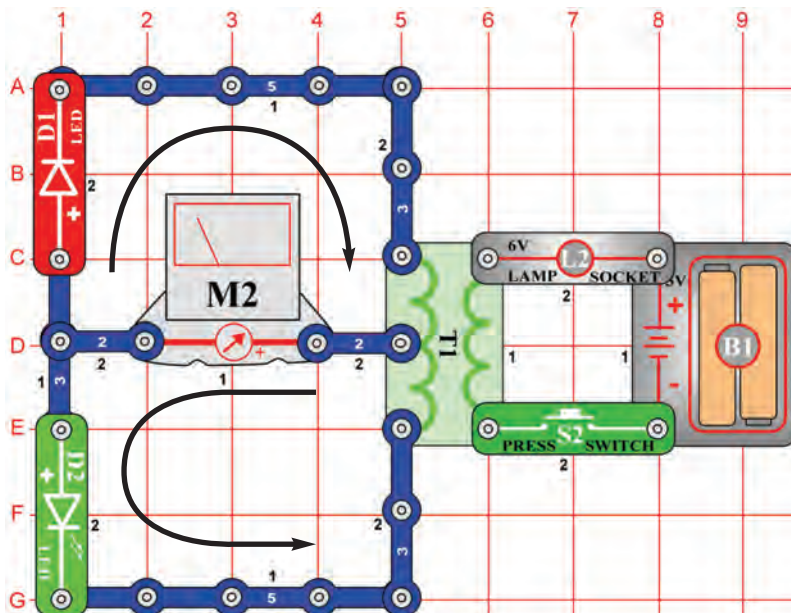

Meter Deflection

OBJECTIVE: To demonstrate the properties of a transformer.

Set the meter (M2) to the LOW (or 10mA) scale. Pressing the press switch (S2) generates a current on the left side of the transformer (T1). The current lights the LED's (D1 & D2) and deflects the meter. There are two current paths as shown by the arrows. Placing the meter in both current paths always measures each current. The top current is produced when the press switch is pressed and the bottom current is produced when the press switch is released.



Project #359

AC to DC Current

OBJECTIVE: To convert an AC current to DC using an LED.

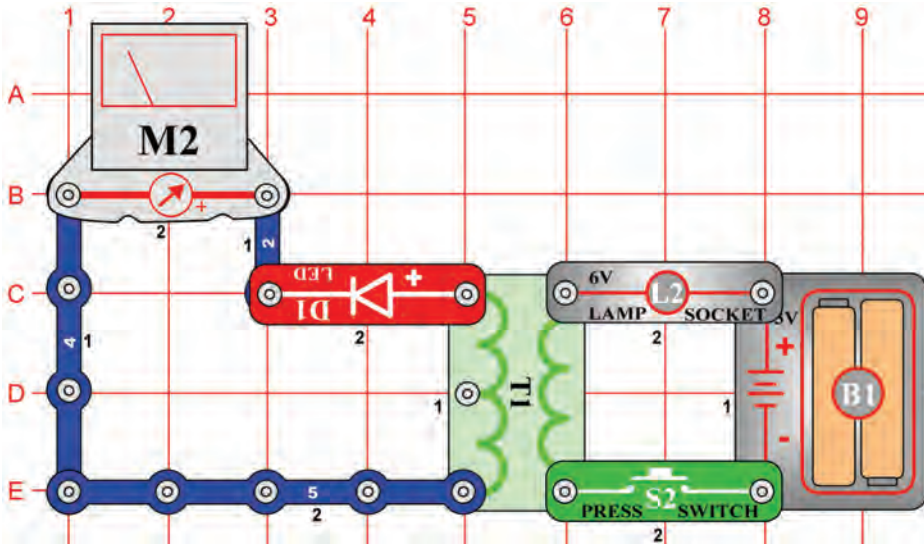

Set the meter (M2) to the LOW (or 10mA) scale. Pressing and releasing the press switch (S2) continuously generates an AC (changing) current. The LED (D1) is used to convert the AC (changing) current to DC (unchanging) current because it only allows the current to flow in one direction. The LED should light as the meter deflects to the right only. Without the LED, the meter would deflect in both directions.



Project #360

Current Meter

OBJECTIVE: To measure the current through a transformer.

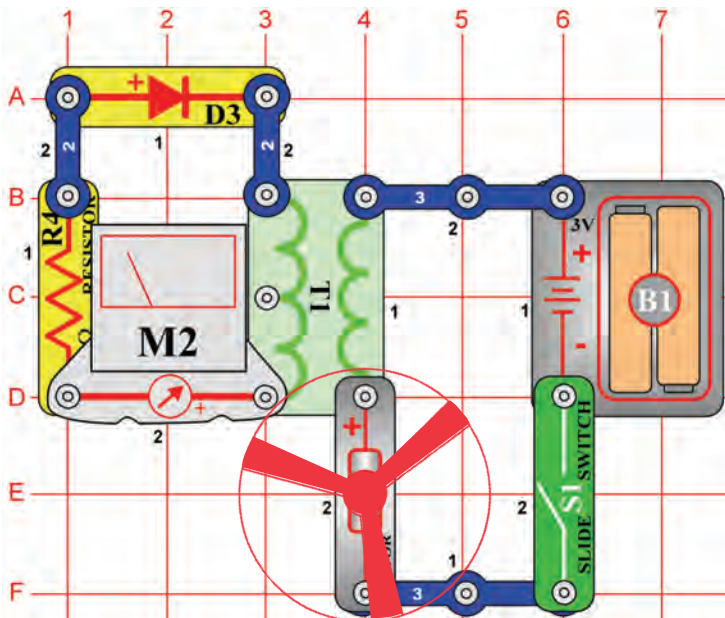

Set the meter (M2) to the LOW (or 10mA) setting. By placing the meter, diode (D3) and current limiting resistor (R4) on the transformer (T1), you can measure the current. Turn on the slide switch (S1) and the motor (M1) starts spinning. The current on the right side of the transformer creates a current on the left side using magnetism.

WARNING: Moving parts. Do not touch the fan or motor during operation. Do not lean over the motor.



Project #361

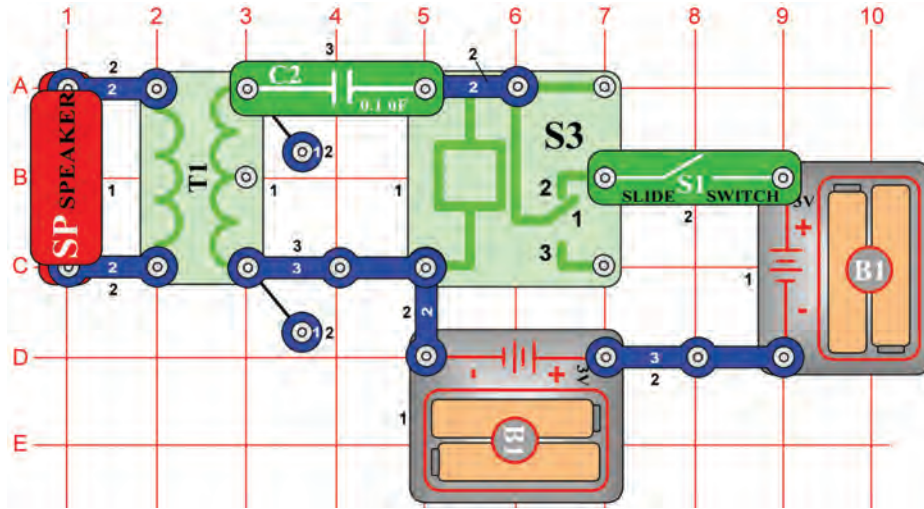

Buzzer, Relay, & Transformer

OBJECTIVE: To use a transformer for a louder buzzer.

Turn on the switch (S1). The speaker (SP) generates a buzzer sound. As in project #353, the relay (S3) is rapidly switched on and off. This causes an AC voltage on the left side of the transformer (T1). The voltage is stepped-down and applied to the speaker, generating the sound.

To make the sound a little louder, replace the 0.1 μ F capacitor (C2) with a 3-snap wire.



Project #362

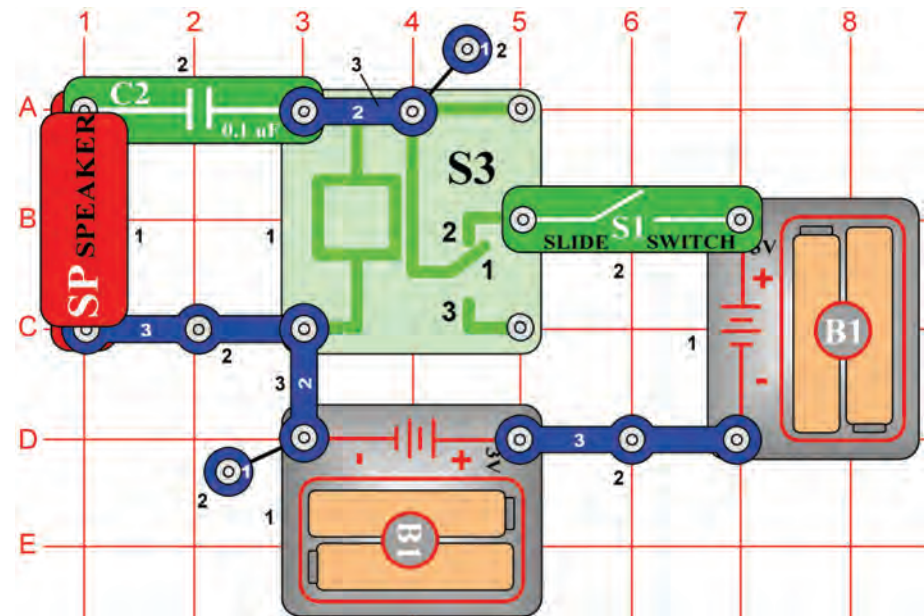

Buzzer & Relay

OBJECTIVE: Make a relay buzzer with speaker.

A speaker (SP) and capacitor (C2) are placed across the coil of the relay (S3). When the slide switch (S1) is turned on, the relay's contacts open and close as in project #353. As the capacitor (C2) charges and discharges, the speaker generates a buzzing sound.

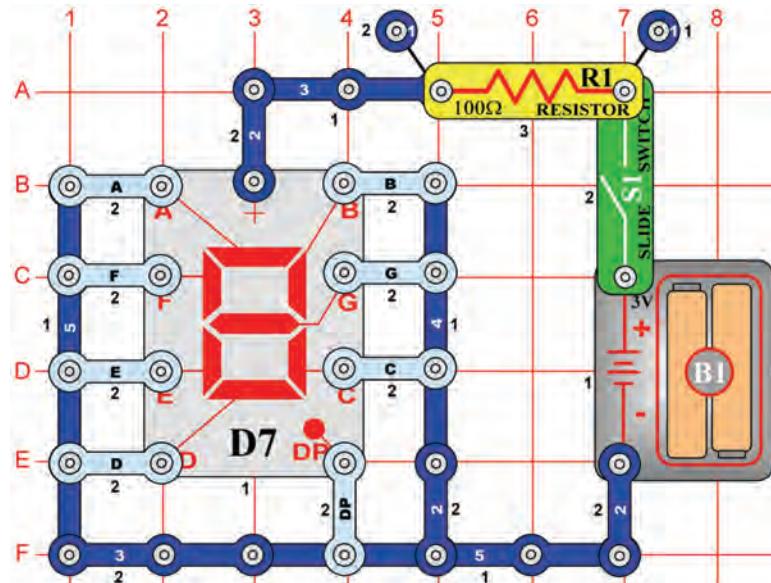

Project #363 Display Capital Letter "F"

OBJECTIVE: To configure the seven segment to display the capital letter "F".

Connect A, E, F, & G to the negative of the battery.

Project #364 Display Capital Letter "H"

OBJECTIVE: To configure the seven segment to display the capital letter "H".

Connect B, C, E, F, & G to the negative of the battery.

Project #365 Display Capital Letter "P"

OBJECTIVE: To configure the seven segment to display the capital letter "P".

Connect A, B, E, F, & G to the negative of the battery.

Project #366 Display Capital Letter "S"

OBJECTIVE: To configure the seven segment to display the capital letter "S".

Connect A, F, G, C, & D to the negative of the battery.

Project #367 Display Capital Letter "U"

OBJECTIVE: To configure the seven segment to display the capital letter "U".

Connect B, C, D, E, & F to the negative of the battery.

Project #368 Display Capital Letter "C"

OBJECTIVE: To configure the seven segment to display the capital letter "C".

Connect A, D, E, & F to the negative of the battery.

Project #369 Display Capital Letter "E"

OBJECTIVE: To configure the seven segment to display the capital letter "E".

Connect A, D, E, F, & G to the negative of the battery.

Project #370 Display "."

OBJECTIVE: To configure the seven segment to display the decimal (DP).

Connect DP to the negative of the battery.

Project #371

Display Letter "b"

OBJECTIVE: To configure the seven segment to display the letter "b".

Connect C, D, E, F, & G to the negative of the battery.

Project #372

Display Letter "c"

OBJECTIVE: To configure the seven segment to display the letter "c".

Connect A, F, & G to the negative of the battery.

Project #373

Display Letter "d"

OBJECTIVE: To configure the seven segment to display the letter "d".

Connect B, C, D, E, & G to the negative of the battery.

Project #374

Display Letter "e"

OBJECTIVE: To configure the seven segment to display the letter "e".

Connect A, B, D, E, F, & G to the negative of the battery.

Project #375

Display Letter "h"

OBJECTIVE: To configure the seven segment to display the letter "h".

Connect F, E, G, & C to the negative of the battery.

Project #376

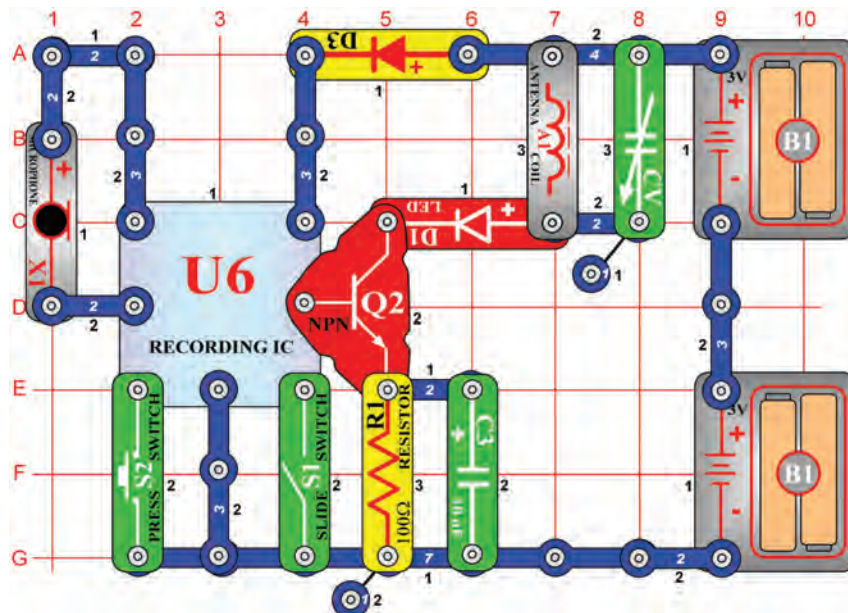

Recorded Voice Transmitter

OBJECTIVE: To hear your voice on the radio.

You need an AM radio for this project. Build the circuit shown and place it next to your AM radio. Tune the radio frequency to where no other station is transmitting. Push the press switch (S2); the red LED (D1) should light for a while, indicating that music is being transmitted to your radio. Tune the adjustable capacitor (CV) and the radio volume control until the music sounds best on the radio. Wait until the music stops.

Turn on the slide switch (S1), you hear a beep signaling that you may begin recording. Talk into the microphone (X1) up to 8 seconds, and then turn off the slide switch (it also beeps after the 8 seconds expires).

Press the press switch (S2) for playback. It plays the recording you made followed by one of three songs. If you press the press switch before the song is over, music will stop. You may press the press switch several times to play all three songs.



Project #377

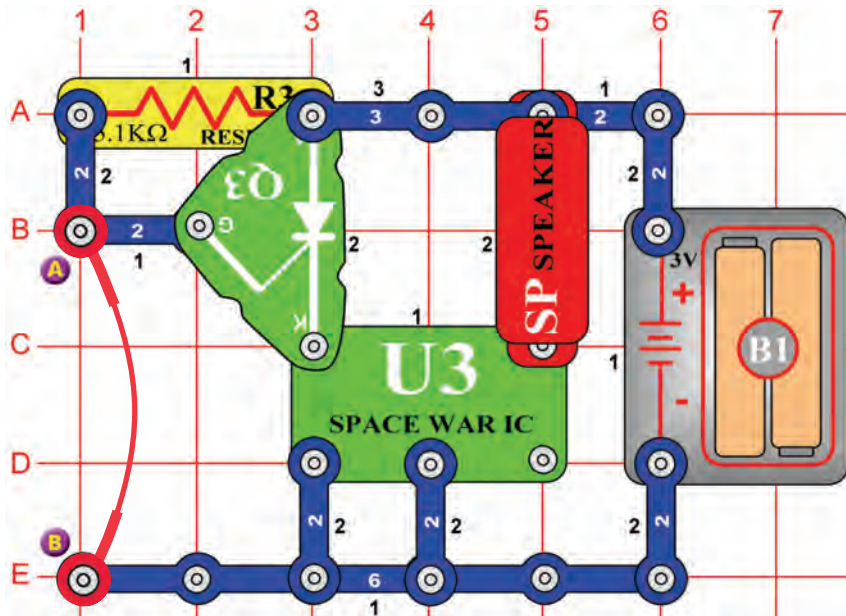

Space War Alarm by SCR

OBJECTIVE: To build an alarm circuit.

The circuit uses the space war IC (U3) and works the same way as project #320. Remove the jumper wire and a space war sound plays.



Project #378 Light Space War Alarm

OBJECTIVE: To build an alarm circuit.

Use the circuit in project #377. Replace the resistor (R3) with the photoresistor (RP) and remove the jumper wire. Cover the photoresistor with your hand. Now slowly remove your hand. The music plays when enough light hits the resistor.



Project #379

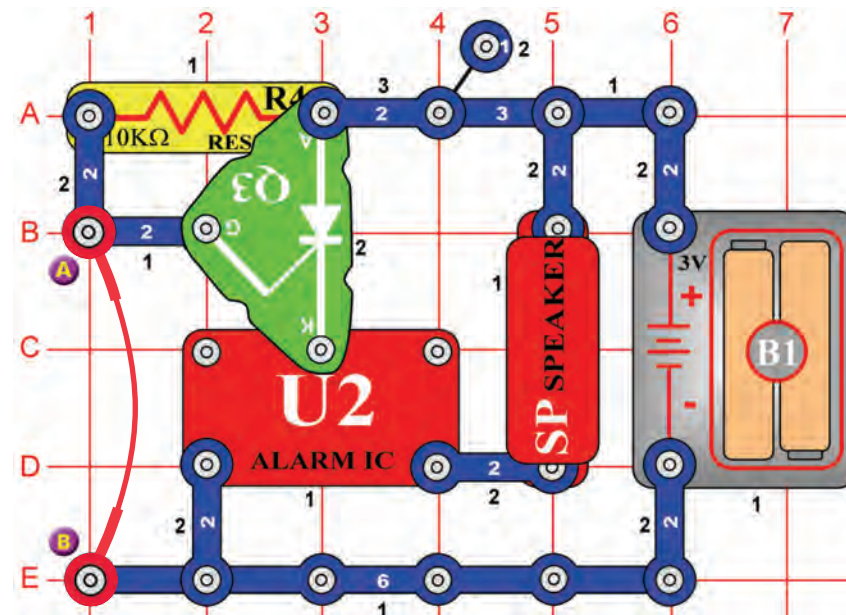

Alarm by SCR

OBJECTIVE: To build an alarm circuit.

The circuit uses the alarm IC (U2) and works the same way as project #377. Remove the jumper wire and an alarm IC sounds.



Project #380 Light & Alarm IC

OBJECTIVE: To build an alarm circuit.

Use the circuit in project #379. Replace the 10kΩ resistor (R4) with the photoresistor (RP) and remove the jumper wire. When enough light strikes the photoresistor, the Alarm IC (U2) plays. Cover the photoresistor with your hand. Now slowly remove it, when enough light hits the resistor, the IC plays.



Project #381

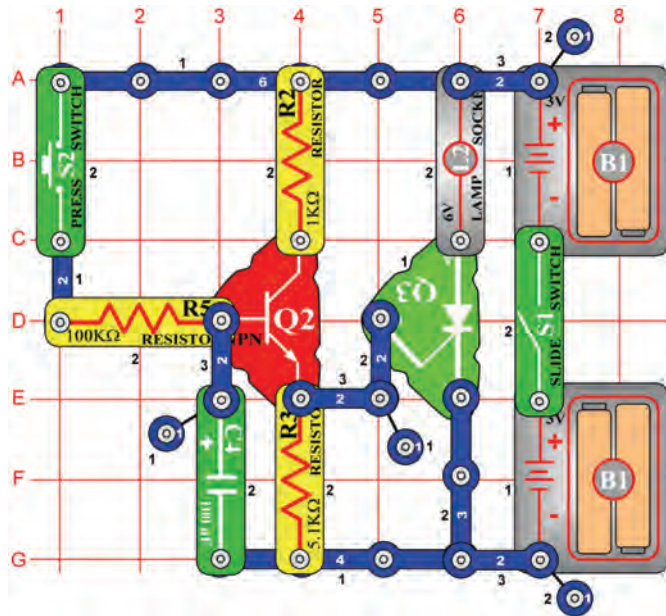

Delay Light

OBJECTIVE: To construct a time delay circuit.

Turn on the slide switch (S1) and the bulb (L2) does not light. Press switch (S2) and slowly the bulb lights.

When the press switch is pressed, current flows to the base of the transistor (Q2) and charges the 100µF capacitor (C4). When the capacitor charges up to more than 1 volt, the transistor (Q2) turns on and triggers the SCR (Q3). The bulb will stay lit until the slide switch is turned off. The values R5 and C4 determine the time it takes until the transistor turns on. The larger the capacitor value, the more time it takes to turn on.



Project #382

Delay Fan

OBJECTIVE: To construct a time delay fan.

Use the circuit in project #381. Replace the lamp (L2) with the motor (M1) and fan, then replace the 3-snap (base grid locations E6-G6) with the lamp (L2). Turn on slide switch (S1) and press down the press switch (S2) to start the motor.

Now replace the 100µF capacitor (C4) with the 470µF capacitor (C5). Turn on slide switch (S1) and press switch (S2). See how long it takes until the motor (M1) spins.



WARNING: Moving parts. Do not touch the fan or motor during operation. Do not lean over the motor.



Project #383

Sound Activated Fan

OBJECTIVE: To build a sound activated fan.

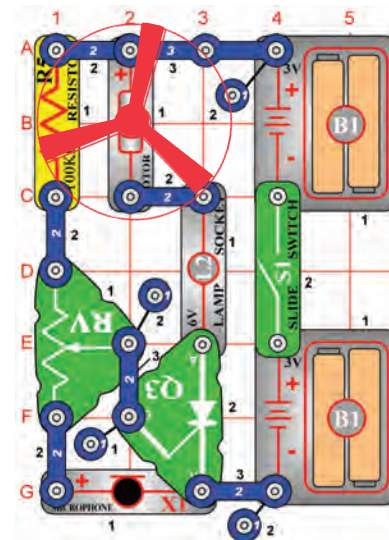

Build the circuit as shown. Place the fan on the motor (M1). Set the lever on the adjustable resistor (RV) toward towards the 100kΩ resistor (R5). Clap to start the motor.



WARNING: Moving parts. Do not touch the fan or motor during operation. Do not lean over the motor.



Project #384

Recording LED Indicator

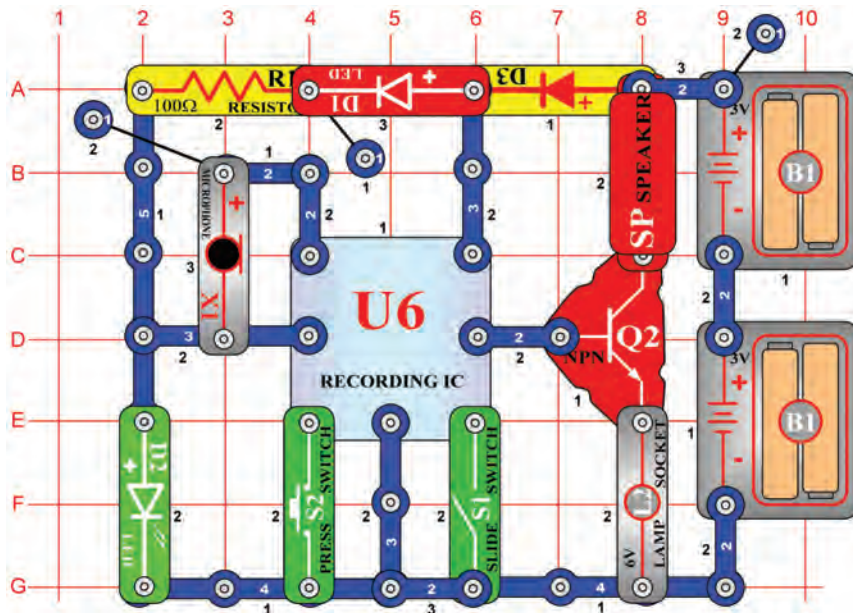

OBJECTIVE: To build a circuit that lights an LED to indicate the recording mode.

The circuit uses sound (beep) and light (LED) to indicate that you are recording. Build the circuit; the red (D1) and green (D2) LED's should light. Now turn on the slide switch (S1). You hear one beep and the green LED turns off. Speak into the microphone (X1) to record a message. When you turn off the slide switch, or the circuit beeps twice (indicating the recording is finished), the green LED turns on again. Make sure that the slide switch is turned off. Press the press switch to hear your recording followed by a song. The lamp (L2) is used to limit current and will not light.



Project #385

Playback & Record with Meter

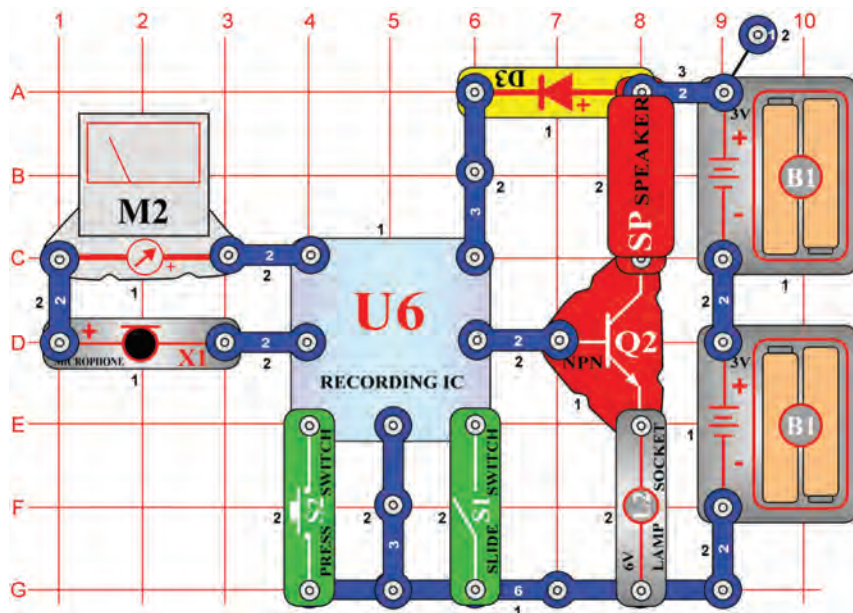

OBJECTIVE: To add a volt meter to the playback and record circuit.

When recording, if the input signal into the microphone (X1) is too high, distortion can occur. To monitor the level, a meter (M2) is placed in series with the microphone.

Set the meter to the LOW (or 10mA) scale. Turn on the slide switch (S1) and the meter deflects to the right. As you speak into the microphone, the meter indicates the change in current. Turn the switch off and then on to record again, but this time speak louder. You will find that the louder you speak, the more the meter deflects. The lamp (L2) is used to limit current and will not light.



Project #386

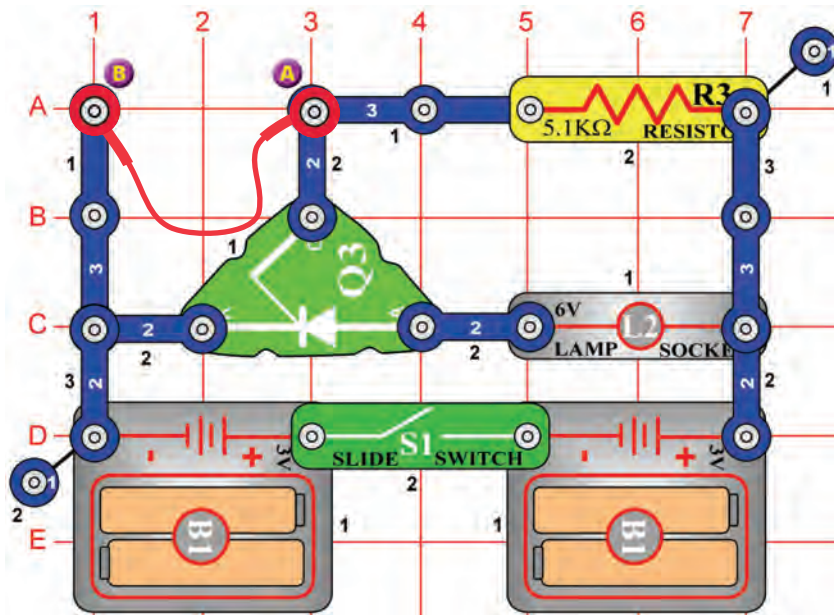

Alarm Light

OBJECTIVE: To light a bulb to indicate an open circuit.

This is another example of a alarm that activates when the circuit is broken. Connect the jumper wire across points A & B and then turn on the slide switch (S1). The lamp (L2) will not light until the jumper wire is disconnected. Then the lamp will not turn off. Turn off the switch to turn the lamp off again. This circuit remembers if there was a break in the connection.



Project #387

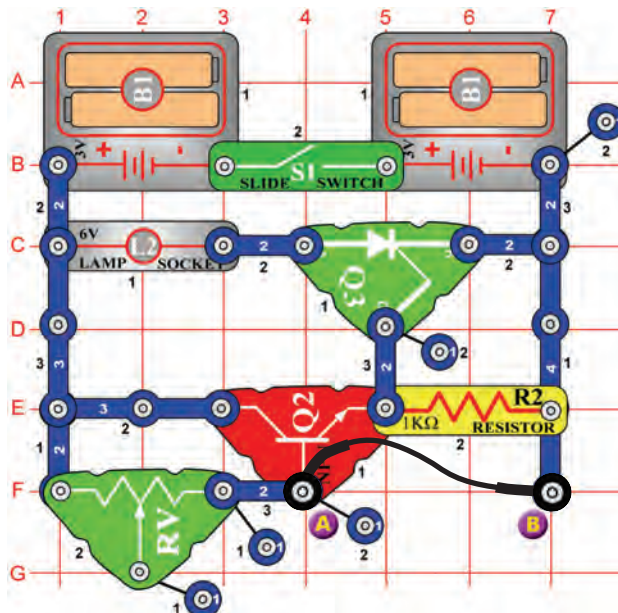

Alarm Light (II)

OBJECTIVE: To light a bulb to indicate an open circuit.

This project is similar to project #386, but uses a transistor (Q2). The lamp (L2) will not light until the jumper wire is disconnected. The jumper wire grounds the base of the transistor, keeping it off. Remove the jumper and the voltage on the base rises; turning the transistor and SCR (Q3) on, and lighting the lamp. Note, the adjustable resistor (RV) is used as a fixed value. Once the SCR is triggered, it will light the lamp even if the jumper wire is replaced. Turn the slide switch (S1) off to turn off the lamp.



Project #388

Night Police Car

OBJECTIVE: To build a night-sensitive police car sound.

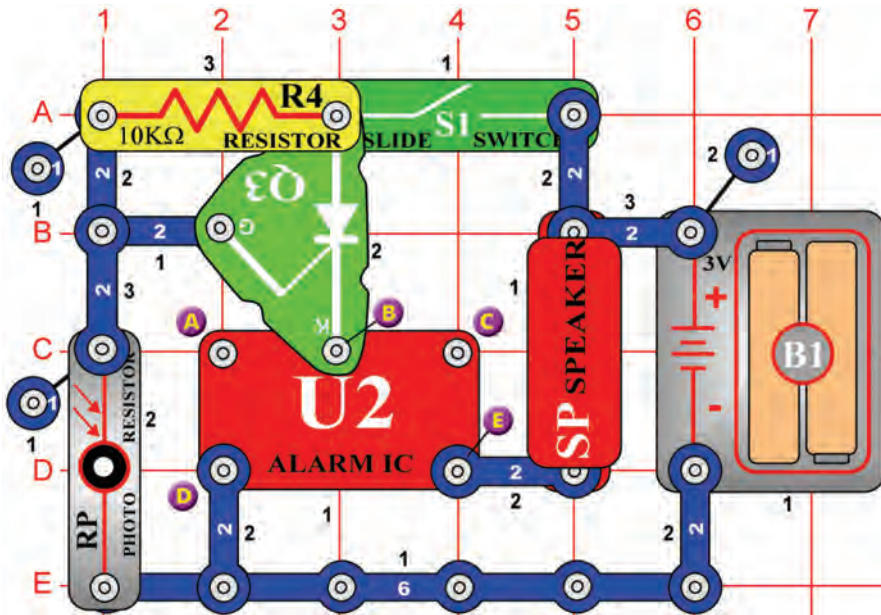

As the photoresistor (RP) is exposed to light, its resistance is very low, thereby connecting the gate of the SCR (Q3) to ground. This prevents the SCR from conducting, connecting the alarm IC (U2) to the batteries. The alarm IC remains off until the light is blocked, triggering the SCR. If the light in the room is not bright, the IC may turn on.

Wave your hands over the photoresistor. Block the light with your hand and the speaker (SP) sounds.



Project #389

Night Machine Gun

OBJECTIVE: To build a night-sensitive machine gun sound.

Use the circuit from project #388. Connect the jumper wire to points B & C for a machine gun sound.



Project #390

Night Fire Engine

OBJECTIVE: To build a night-sensitive fire engine sound.

Use the circuit from project #388. Connect the jumper wire to points A & B for a fire engine sound.



Project #391

Night Ambulance

OBJECTIVE: To build a night-sensitive ambulance sound.

Use the circuit from project #388. Connect the jumper wire to points A & D for an ambulance sound.



Project #392

Daytime Light Police Car

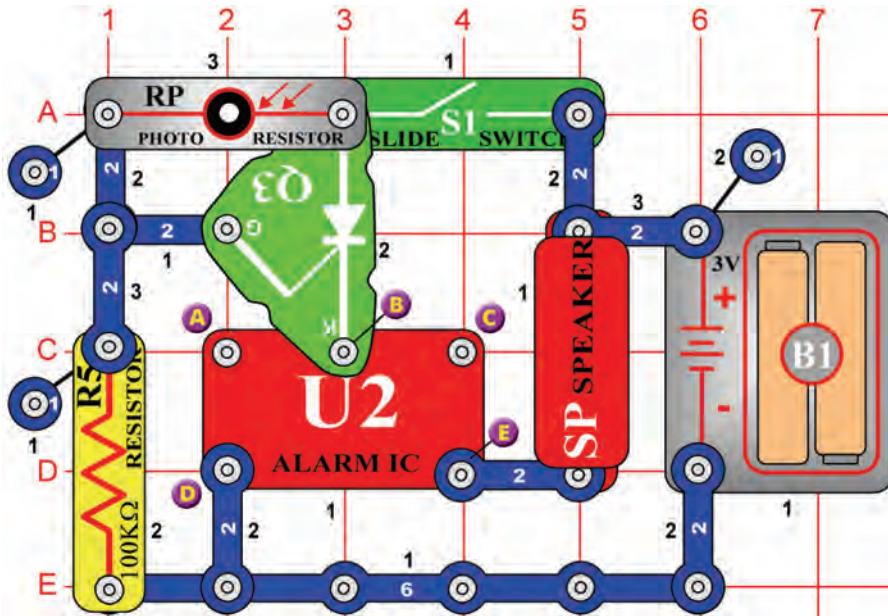

OBJECTIVE: To build a light-sensitive police car sound.

As long as the photoresistor (RP) is exposed to light, the alarm IC (U2) outputs a signal to the speaker (SP). Block the light with your hand and the sound will stop.



Project #393 Daytime Light Machine Gun

OBJECTIVE: To build a light-sensitive machine gun sound.

Use the circuit from project #392. Connect the jumper wire to points B & C. The sound of a machine gun will be heard when the room is not dark.



Project #394 Daytime Light Fire Engine

OBJECTIVE: To build a light-sensitive fire engine sound.

Use the circuit from project #392. Connect the jumper wire to points A & B for a fire engine sound, when room is not dark.



Project #395 Daytime Light Ambulance

OBJECTIVE: To build a light-sensitive ambulance sound.

Use the circuit from project #392. Connect the jumper wire to points A & D for an ambulance sound.



Project #396

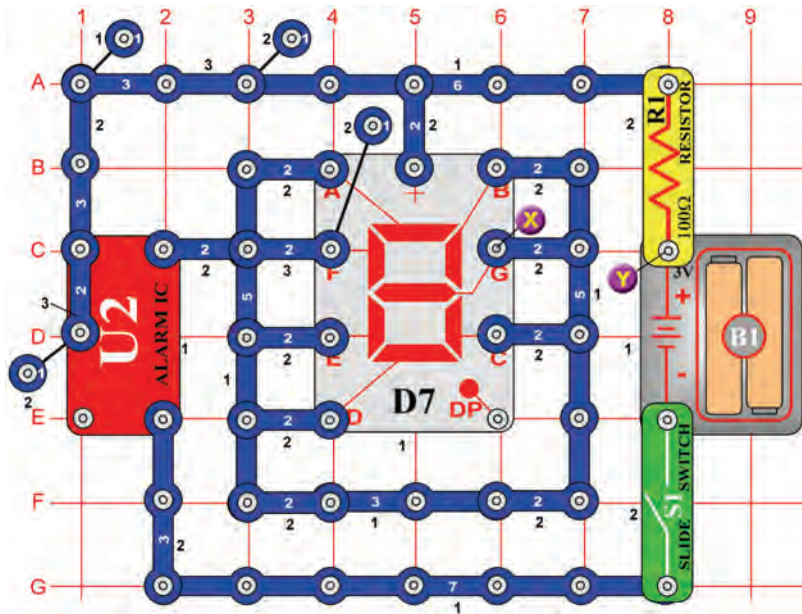

Flashing 8

OBJECTIVE: Use the Alarm IC as a switch to flash the number “8”.

Turn on the slide switch (S1) and the number 8 starts flashing. The segments are powered by connecting them to the IC's (U2) output.



Project #397 Flashing 8 with Sound

OBJECTIVE: To build a circuit so you can hear and see the 8 flash.

Use the circuit in project #396. Connect the speaker (SP) across points X & Y to see and hear the IC's (U2) output.



Project #398

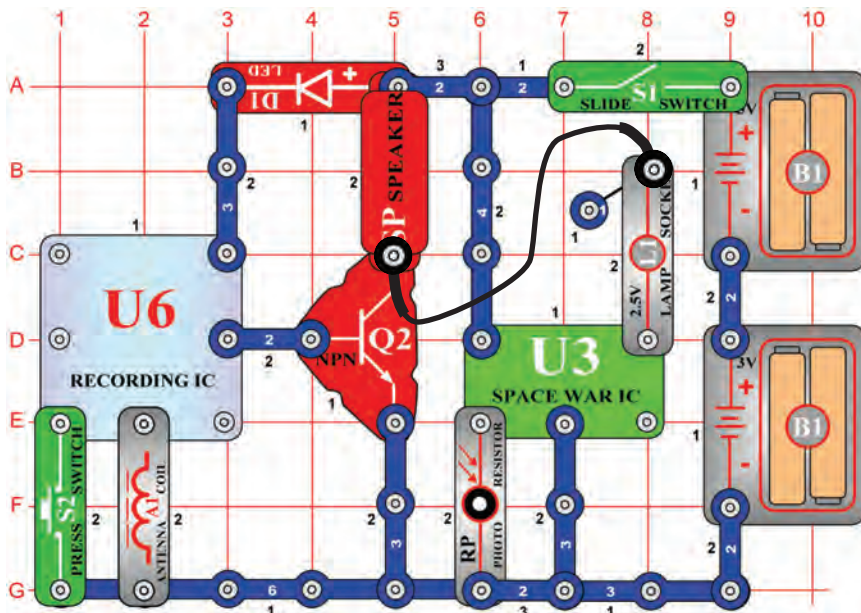

Musical Space War

OBJECTIVE: To combine the sound effects of the recorder and space war integrated circuits.

Turn on the slide switch (S1) and you hear space war sounds as the lamp (L1) flashes. If you wave your hand over the photoresistor (RP), the sound changes. If you keep the photoresistor covered, then the sound will stop.

Press the press switch (S2) and you will hear music in addition to any space war sounds that are playing. Press the press switch again to change the music. You will also hear any recording you had previously with other projects.

Replace the lamp with the 100Ω resistor (R1) to reduce the loudness.



Project #399

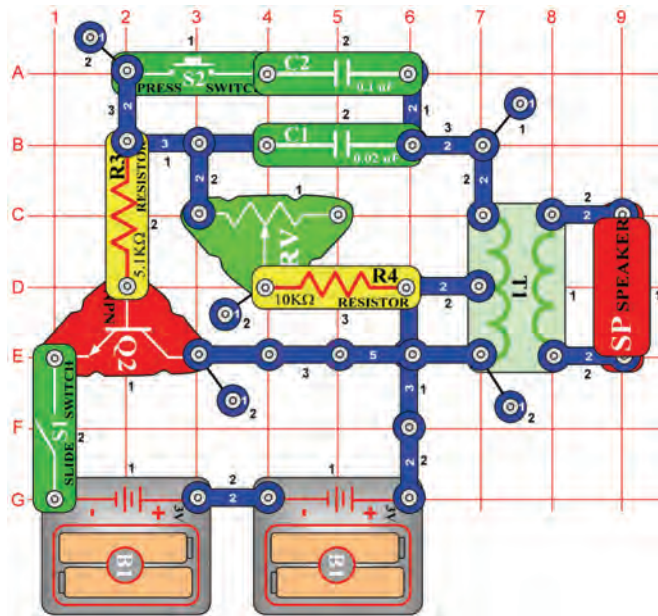

Electronic Noisemaker

OBJECTIVE: To make different tones with an oscillator.

Build the circuit and turn on the slide switch (S1), you hear a high-frequency tone. Press the press switch (S2) and move the adjustable resistor (RV) control around to change to frequency of the tone. Replace the 0.1μF capacitor (C2) with the 10μF capacitor (C3, "+" on the right) to lower the frequency of the tone.



Project #400

Electronic Noisemaker (II)

OBJECTIVE: To show a variation of project #399.

You can also change the frequency by changing the resistance in the oscillator. Replace the 10KΩ resistor (R4) with the 100KΩ resistor (R5), this can be done with either the 0.1μF (C2) or 10μF (C3) capacitors in the circuit.



Project #401

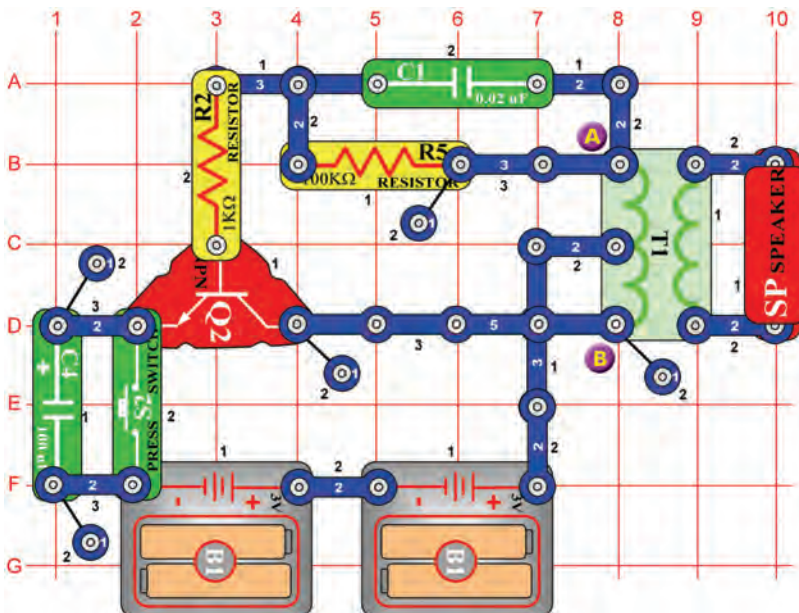

Bee

OBJECTIVE: To make different sounds with an oscillator.

Build the circuit and press the press switch (S2) a few times, you hear cute sounds like a bumble bee. Replace the 0.02μF capacitor (C1) with 0.1μF capacitor (C2) or 10μF capacitor (C3, "+" on the right) to change the sound.



Project #402

Bee (II)

OBJECTIVE: Show a variation of project #401.

Place the 0.02μF capacitor (C1) back in the circuit. Remove the speaker (S1) from the circuit and place the whistle chip (WC) across the transformer (T1) at points labeled A & B on the circuit layout. Listen to the sounds as you press the press switch (S2). Replace the 0.02μF capacitor (C1) with 0.1μF capacitor (C2) or 10μF capacitor (C3, "+" on the right) to change the sound.



Project #403

Bee (III)

OBJECTIVE: Show a variation of project #401.

Replace the 100μF capacitor (C4) with the 10μF capacitor (C3) or the 470μF capacitor (C5) to change the duration of the sound. Use either the speaker circuit in project #401 or the whistle chip circuit in project #402.



Project #404

Oscillator Sound

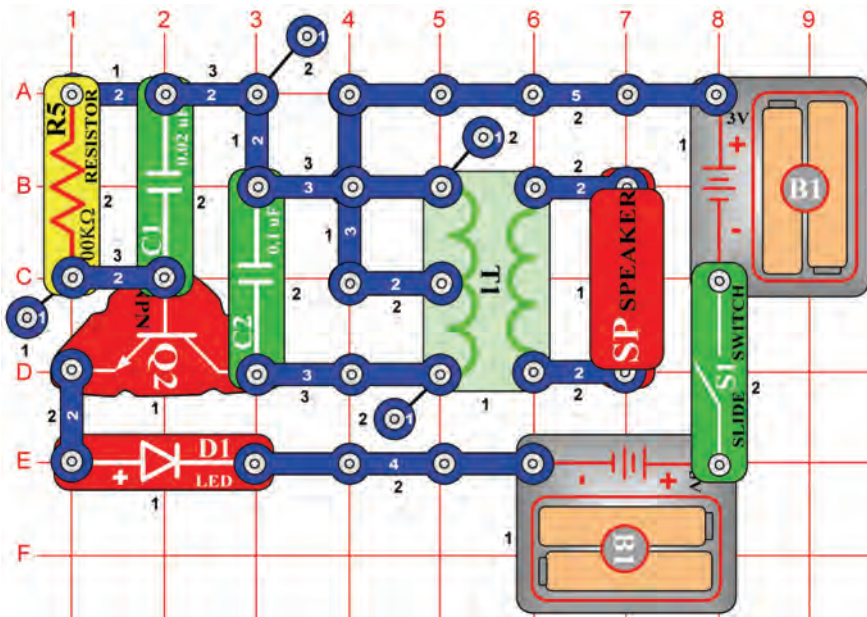

OBJECTIVE: Build an oscillator circuit.

Turn on the slide switch (S1) and the LED (D1) lights as the speaker (SP) emits a tone. The circuit oscillates and generates an AC voltage across the speaker through the transformer (T1).



Project #405 Oscillator Sound (II)

OBJECTIVE: Show variations of project #404.

Use the circuit in project #404. In this circuit, you will change the tone by adding more capacitance. Place the whistle chip (WC) on top of capacitor (C1). Turn on the slide switch (S1) and you now hear a lower tone. Adding the more capacitance lowers the oscillating frequency.



Project #406 Oscillator Sound (III)

OBJECTIVE: Show variations of project #404.

Use the circuit in project #404. Place the whistle chip (WC) in parallel with the capacitor (C2) by placing it on the left side of the transformer (T1). Turn on the slide switch (S1) and you now hear a lower tone.



Project #407 Oscillator Sound (IV)

OBJECTIVE: Show variations of project #404.

Use the circuit in project #404. Using a 1-snap, place the 10μF capacitor (C3) on top of the 100kΩ resistor (R5), with the "+" side on point A1. Turn on the slide switch (S1) and you should hear a much lower sound than the previous projects.



Project #408 Oscillator Sound (V)

OBJECTIVE: Show variations of project #404.

Use the circuit in project #404. Replace the 100kΩ resistor (R5) with the photoresistor (RP). Wave your hand over the photoresistor. Now, as the resistance changes, so does the oscillator frequency.



Project #409

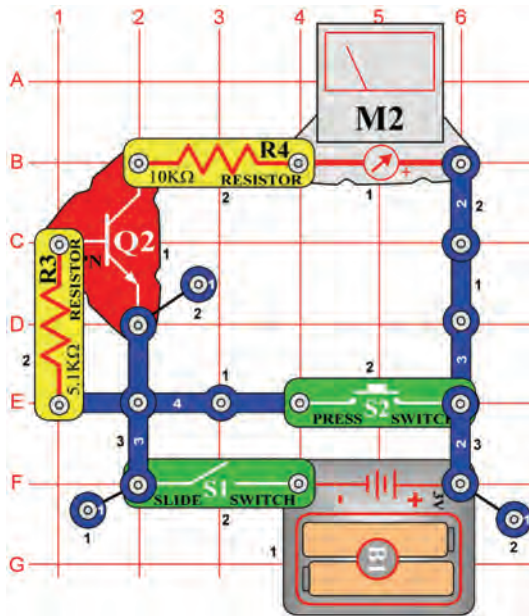

Transistor Tester

OBJECTIVE: To build a circuit that checks the transistor.

Set the meter (M2) to the LOW (or 10mA) setting. Turn on the switch (S1), the meter does not move. Press the switch (S2), the meter deflects and points to 10. This indicates the transistor (Q2) is GOOD. The meter would only deflect a little or not at all for a BAD transistor.



Project #410

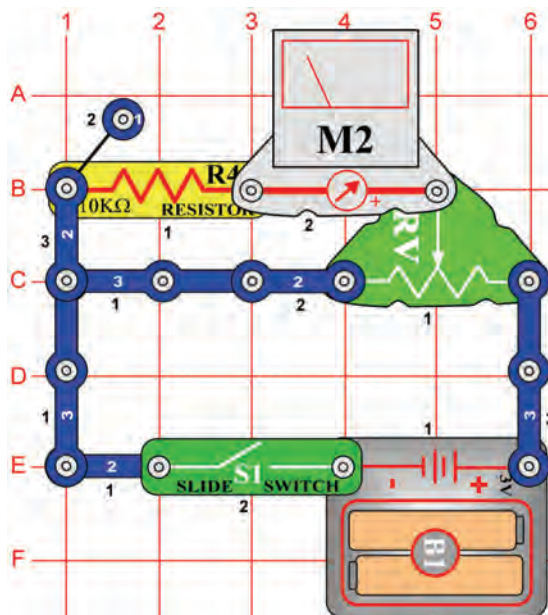

Adjustable Voltage Divider

OBJECTIVE: To make an adjustable current path.

Set the meter (M2) to the LOW (or 10mA) setting. This circuit is a simple voltage divider. When the adjustable resistor (RV) is set to the far right, the voltage across the resistors (R4) and (RV) are equal. Adjust resistor (RV) to the left, the meter deflects less, as the voltage decreases.

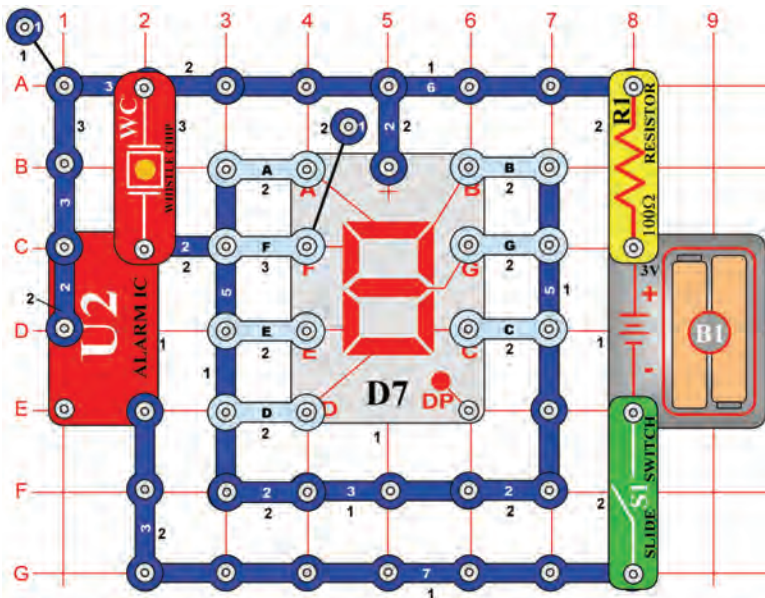

Project #411

Automatic Display Capital Letter “C”

OBJECTIVE: To construct a flashing display for the capital letter C.

Connect segments A, D, E & F to the circuit. Turn on the switch (S1), the display flashes and the whistle chip (WC) buzzes on and off.



Project #412

Automatic Display Capital Letter “E”

OBJECTIVE: To construct a flashing display for the capital letter E.

Use the circuit from project #411. Connect A, D, E, F, & G to the circuit. Turn on the switch (S1), the display flashes and the whistle chip (WC) buzzes on and off.



Project #413

Automatic Display Capital Letter “F”

OBJECTIVE: To construct a flashing display for the capital letter F.

Use the circuit from project #411. Connect A, E, F, & G to the circuit. Turn on the switch (S1), the display flashes and the whistle chip (WC) buzzes on and off.



Project #414

Automatic Display Capital Letter “H”

OBJECTIVE: To construct a flashing display for the capital letter H.

Use the circuit from project #411. Connect B, C, E, F, & G to the circuit. Turn on the switch (S1), the display flashes and the whistle chip (WC) buzzes on and off.



Project #415

Automatic Display Capital Letter “P”

OBJECTIVE: To construct a flashing display for the capital letter P.

Use the circuit from project #411. Connect A, B, E, F, & G to the circuit. Turn on the switch (S1), the display flashes and the whistle chip (WC) buzzes on and off.



Project #416

Automatic Display Capital Letter “S”

OBJECTIVE: To construct a flashing display for the capital letter S.

Use the circuit from project #411. Connect A, F, G, C, & D to the circuit. Turn on the switch (S1), the display flashes and the whistle chip (WC) buzzes on and off.



Project #417

Automatic Display Capital Letter “U”

OBJECTIVE: To construct a flashing display for the capital letter U.

Use the circuit from project #411. Connect B, C, D, E, & F to the circuit. Turn on the switch (S1), the display flashes and the whistle chip (WC) buzzes on and off.



Project #418

Automatic Display Capital Letter “L”

OBJECTIVE: To construct a flashing display for the capital letter L.

Use the circuit from project #411. Connect D, E, & F to the circuit. Turn on the switch (S1), the display flashes and the whistle chip (WC) buzzes on and off.

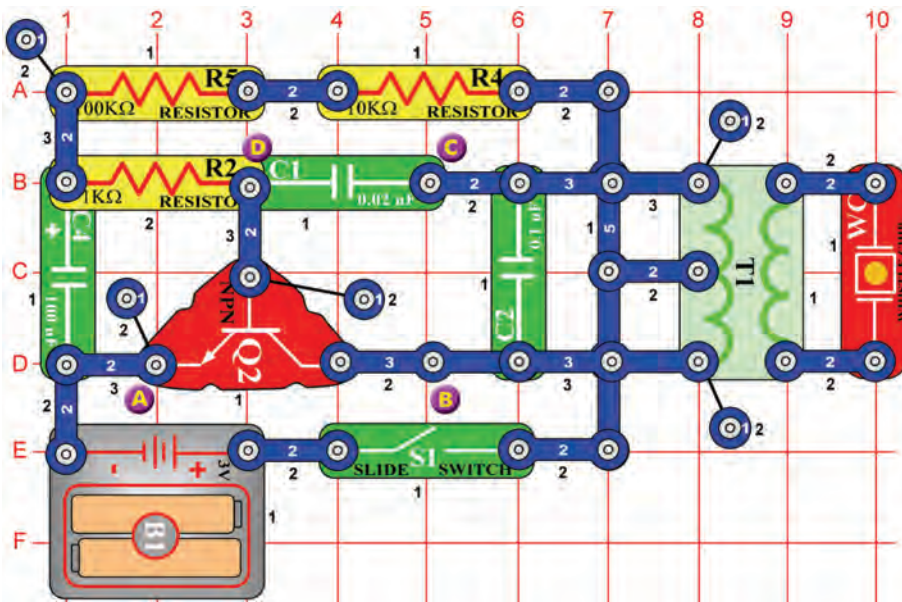

Project #419 Whistle Chip Sounds

OBJECTIVE: To make sounds from the whistle chip.

Turn on the switch (S1). As the circuit oscillates, the plate in the whistle chip vibrates and generates sound.

Project #420 Whistle Chip Sounds (II)

OBJECTIVE: Show variations of project #419.

Connect the whistle chip (WC) across points B & C.

Project #421 Whistle Chip Sounds (III)

OBJECTIVE: Show variations of project #419.

Use the circuit in project #419. Connect the whistle chip (WC) across points C & D. You should hear a faster sound.

Project #422 Whistle Chip Sounds (IV)

OBJECTIVE: Show variations of project #419.

Use the circuit in project #419, but replace the 100μF capacitor (C4) with the 10μF capacitor (C3).

Project #423 Whistle Chip Sounds (V)

OBJECTIVE: Show variations of project #419.

Use the circuit in project #419, but replace the 100μF capacitor (C4) with the 470μF capacitor (C5).

Project #424 Whistle Chip Sounds (VI)

OBJECTIVE: Show variations of project #419.

Use the circuit in project #419, but replace the 100μF capacitor (C4) with the 10μF capacitor (C3) and connect the whistle chip across points B & C. You can also connect the whistle chip across points C & D.



Project #425

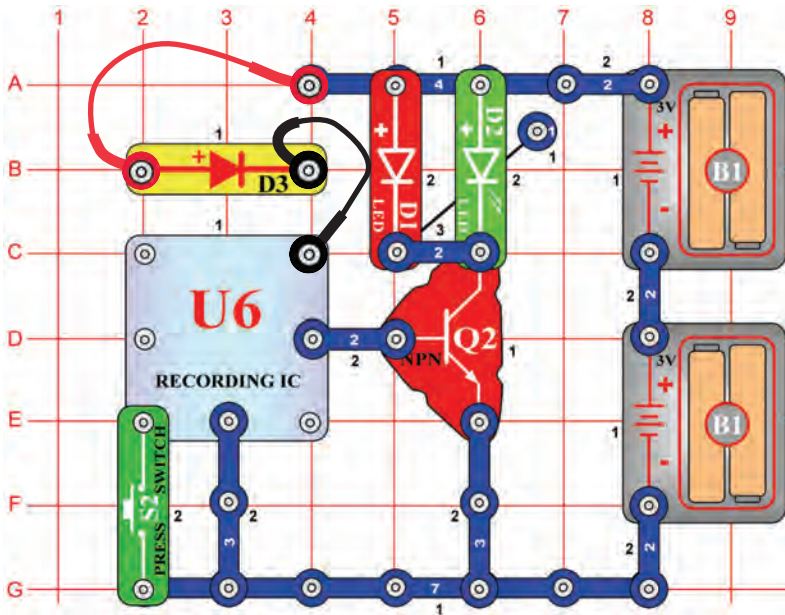

LED Music

OBJECTIVE: To light the LED's using the recording IC.

The recording IC (U6) lights the LED's (D1 & D2) instead of driving the speaker (SP). Press the press switch (S2) once. The LED's light and then turn off after a while. Press the press switch again and see how long the second song plays. When the second song stops, press the press switch (S2) again to play the third song.



Project #426 Light-controlled LED Time Delay

OBJECTIVE: Show variations of project #425.

Use the circuit in project #425. Replace the press switch (S2) with the photoresistor (RP). Turn the LED's on and off by waving your hand over the photoresistor.



Project #427 Touch-controlled LED Time Delay

OBJECTIVE: Show variations of project #425.

Use the circuit in project #425. Replace the press switch (S2) with the PNP transistor (Q1, arrow on U6 and a 1-snap on point F1). Turn the LED's on and off by touching grid points F1 & G2 at the same time. You may need to wet your fingers.



Project #428

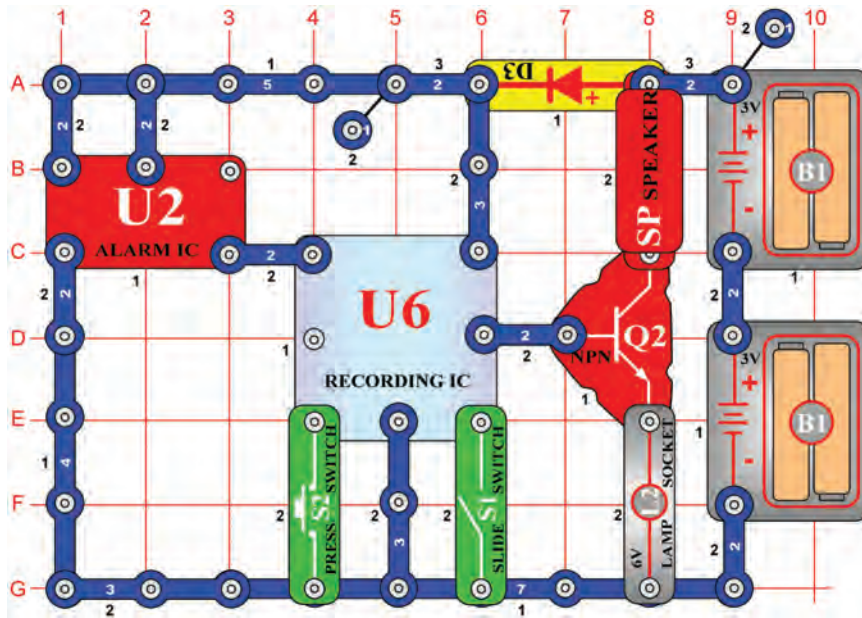

Alarm Recorder

OBJECTIVE: *To record the sound from the alarm IC.*

The circuit records the sound from the alarm IC (U2) into the recording IC (U6). Turn on the switch (S1). The first beep indicates that the IC has begun recording. When you hear two beeps, the recording has stopped. Turn off the slide switch (S1) and press the switch (S2). You will hear the recording of the alarm IC before each song is played. The lamp (L2) is used to limit current and will not light.



Project #429 Alarm Recorder (II)

OBJECTIVE: *Record the sound from the alarm IC.*

Use the circuit in project #428. Remove the 2-snap from A1 to B1. Turn on the switch (S1). The first beep indicates that the IC (U6) has begun recording. When you hear two beeps, turn off the switch (S1), press the switch (S2), and the new recording plays.



Project #430 Machine Gun Recorder

OBJECTIVE: *To record the sound of a machine gun.*

Use the circuit in project #428. Move the 2-snap from A1 - B1 to 3A - 3B. Turn on the switch (S1). The first beep indicates that the IC (U6) has begun recording. When you hear two beeps, turn off the switch (S1), press the switch (S2), and the machine gun sound plays.



Project #431

Time Delay

1-7 Seconds

OBJECTIVE: *To build a time delay circuit.*

The length of time the motor (M1) runs depends on the position of the adjustable resistor (RV). When the press switch (S2) is pressed, the 470 μ F capacitor (C5) charges. As the press switch is released, C5 discharges through the resistors R4 and RV, turning the transistor (Q2) on. Transistor Q2 connects the relay (S3) to the batteries, the contacts switch, and the motor (M1) spins. As the voltage decreases, Q2 will turn off and the motor will stop spinning.

Setting RV to the right (large resistance) sets a long discharge time. To the left, a short discharge time.

Turn on the switch (S1), the red LED (D1) lights. Now press and release the switch (S2), the bulb lights and the motor spins.

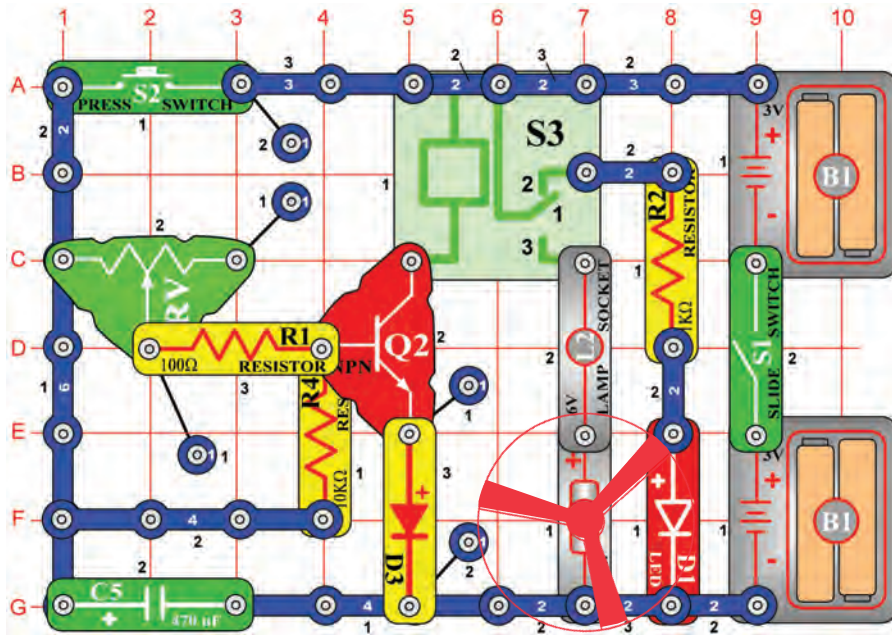

WARNING: Moving parts. Do not touch the fan or motor during operation. Do not lean over the motor.



Project #432

Time Delay

OBJECTIVE: *To see how the capacitor value affects the time.*

Use the circuit in project #431. Replace the 470 μ F capacitor (C5) with the 100 μ F capacitor (C4). Set the adjustable resistor (RV) to the far right, turn on the switch (S1), then press and release the switch (S2). The motor (M1) spins and bulb (L2) lights for about 3 seconds. Adjust the adjustable resistor to the left for a much shorter time.



Project #433

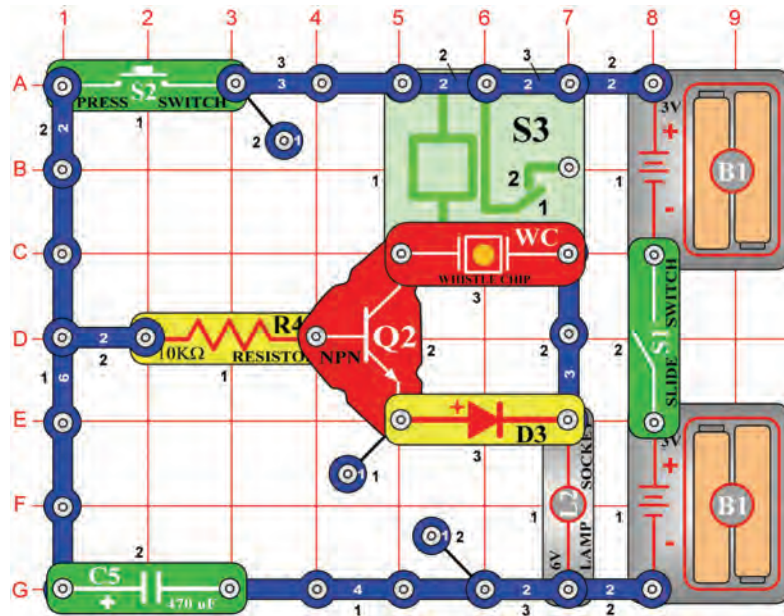

Manual 7 Second Timer (II)

OBJECTIVE: To build a manual timer using a relay and whistle chip.

This circuit is similar to project #431 except now the whistle chip (WC) will also make sound.



Project #434

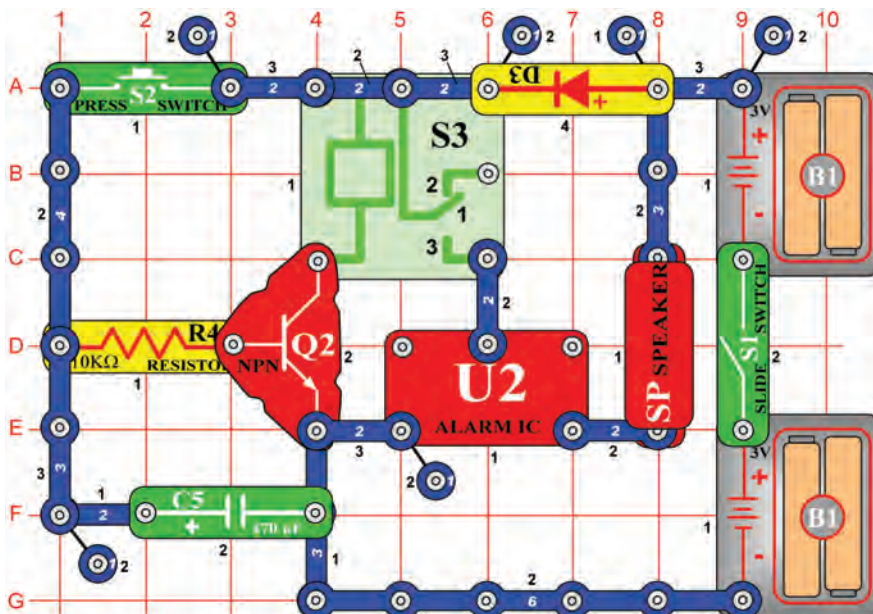

15 Second Alarm

OBJECTIVE: To build a circuit that sounds the speaker for 15 seconds.

As in project #431, the transistor (Q2) acts as a switch, connecting the relay (S3) and the alarm IC (U2) to the batteries. As long as there is a voltage on the transistor's base, the alarm IC sounds.

Turn on the slide switch (S1) and then press the switch (S2). The transistor turns on, the capacitor (C5) charges up, and the alarm sounds. Release the press switch (S2). As the capacitor discharges, it keeps the transistor on. The transistor will turn off when the capacitor is almost discharged, about 15 seconds. The relay contacts will switch and the alarm will turn off.

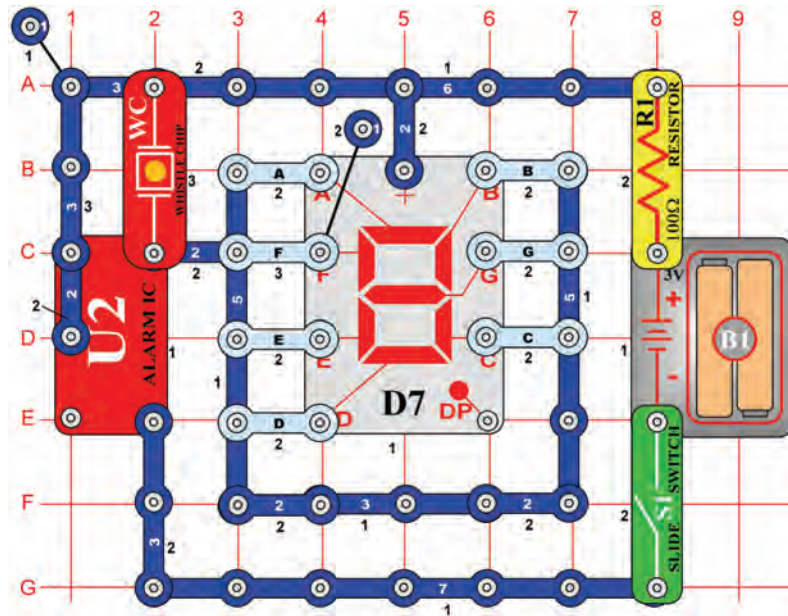

Project #435

Flashing "1 & 2"

OBJECTIVE: Use the Alarm IC as a switch to flash the numbers "1 & 2".

Connect segments B & C to the circuit. Turn on the slide switch (S1) and the number "1" should be flashing. Now, connect A, B, G, E, & D to flash the number "2".

Project #436

Flashing "3 & 4"

OBJECTIVE: Use the Alarm IC as a switch to flash the numbers "3 & 4".

Use the circuit in project #435. Connect A, B, G, C, & D to the circuit. Turn on the slide switch (S1) and the number "3" should be flashing. Now, connect C, B, G & F to flash the number "4".

Project #437

Flashing "5 & 6"

OBJECTIVE: Use the Alarm IC as a switch to flash the numbers "5 & 6".

Use the circuit in project #435. Connect A, F, G, C & D to the circuit. Turn on the slide switch (S1) and the number "5" should be flashing. Now, connect A, C, D, E, F & G to flash the number "6".

Project #438

Flashing "7 & 8"

OBJECTIVE: Use the Alarm IC as a switch to flash the numbers "7 & 8".

Use the circuit in project #435. Connect A, B, & C to the circuit. Turn on the slide switch (S1) and the number "7" should be flashing. Now, connect A, B, C, D, E, F & G to flash the number "8".

Project #439

Flashing "9 & 0"

OBJECTIVE: Use the Alarm IC as a switch to flash the numbers "9 & 0".

Use the circuit in project #435. Connect A, B, C, D, F, & G to the circuit. Turn on the switch (S1) and the number "9" should be flashing. Now, connect A, B, C, D, E, & F to flash the number "0".

Project #440

Flashing "b & c"

OBJECTIVE: Use the Alarm IC as a switch to flash the letters "b & c".

Use the circuit in project #435. Connect C, D, E, F & G to the circuit. Turn on the slide switch (S1) and the letter "b" should be flashing. Now, connect A, F & G to flash the letter "c".

Project #441

Flashing "d & e"

OBJECTIVE: Use the Alarm IC as a switch to flash the letters "d & e".

Use the circuit in project #435. Connect B, C, D, E, & G to the circuit. Turn on the slide switch (S1) and the letter "d" should be flashing. Now, connect A, B, D, E, F & G to flash the letter "e".

Project #442

Flashing "h & o"

OBJECTIVE: Use the Alarm IC as a switch to flash the letters "h & o".

Use the circuit in project #435. Connect C, E, F, & G to the circuit. Turn on the slide switch (S1) and the letter "h" should be flashing. Now, connect C, D, E, & G to flash the letter "o".

Project #443

Flashing "A & J"

OBJECTIVE: Use the Alarm IC as a switch to flash the letters "A & J".

Use the circuit in project #435. Connect A, B, C, E, F, & G to the circuit. Turn on the slide switch (S1) and the capital letter "A" should be flashing. Now, connect B, C, & D to flash the capital letter "J".



Project #444

Alarm Timer

OBJECTIVE: To connect the alarm IC to a timer circuit.

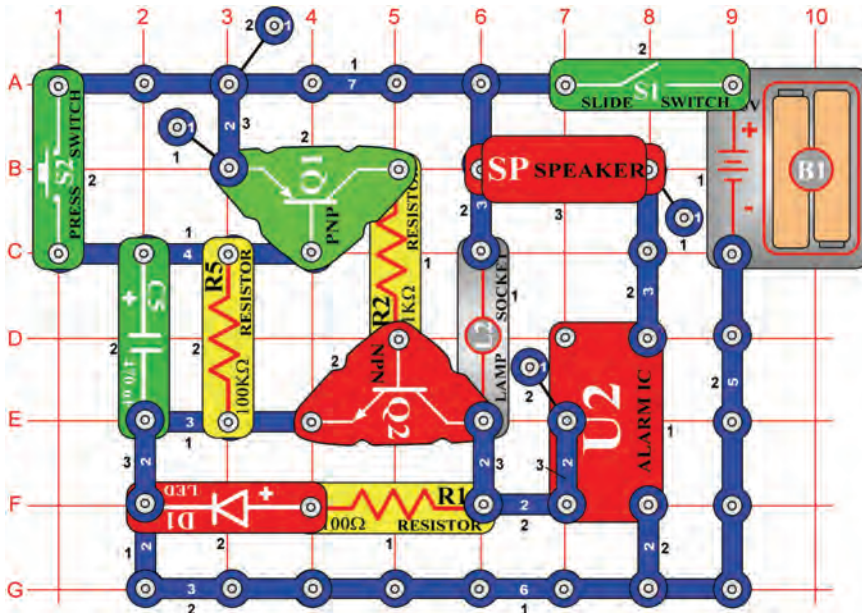

Turn on the slide switch (S1) and the alarm may sound and slowly drift away as the lamp (L2) brightens. Press the press switch (S2) and the alarm sounds at full volume as the LED (D1) lights. Capacitor C5 is also charged. Release the press switch; the alarm IC (U2) still sounds because the voltage from the discharging C5 keeps Q1 and Q2 off. As the capacitor's voltage drops, the LED will turn off and the sound will slowly stop.

Replace resistor R5 and capacitor C5 with different values and see how it affects the circuit.



Project #445 Alarm Timer (II)

OBJECTIVE: To change the time by switching the resistor and capacitor.



Project #446 Alarm Timer (III)

OBJECTIVE: To modify project #285 for a different sound.

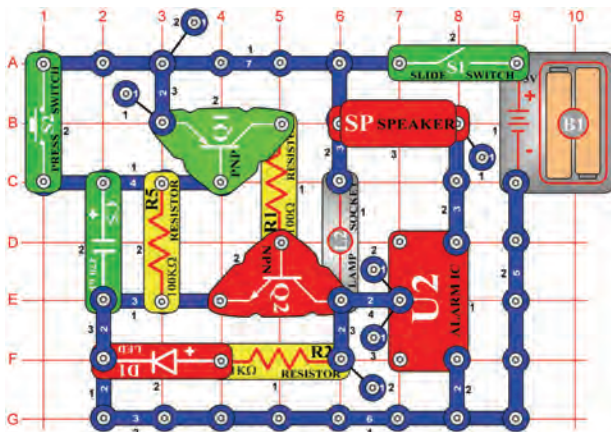

Build this circuit using the following combinations for R5 and C5:

R5 & C3, R4 & C4, and R4 & C5.

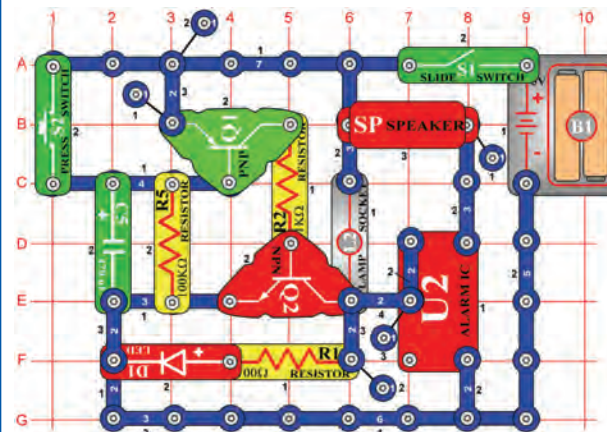

Replace the 1-snap wire from the middle snap on U2 with a 2-snap and connect it to grid location D7 & E7. The circuit now produces a different sound. Change R5 and C5 with the following combinations for R5 and C5:

R5 & C3, R4 & C4, and R4 & C5.

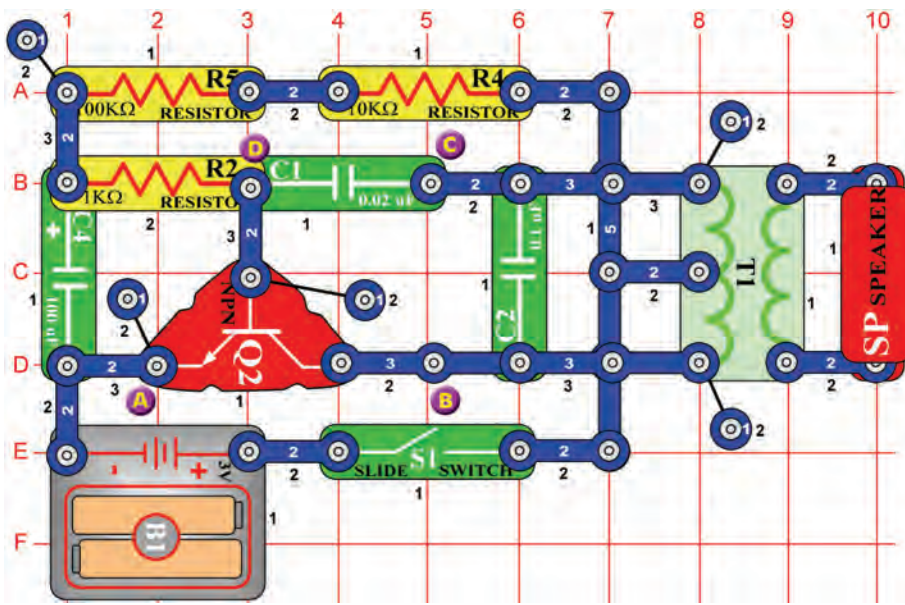

Project #447 Bird Sounds

OBJECTIVE: *To create bird sounds.*

Turn on the switch (S1). The circuit makes a bird sound.

Project #448 Bird Sounds (II)

OBJECTIVE: *To create bird sounds.*

Use the circuit in project #447. Replace the 100μF (C4) capacitor with the 10μF capacitor (C3), the tone should sound like a buzzer. Now use the 470μF capacitor (C5) and hear how the tone gets longer between chirps.

Project #449 Bird Sounds (III)

OBJECTIVE: *To create bird sounds.*

Use the circuit in project #447. Using the jumper wires, connect the whistle chip (WC) across points A & B and the sound changes.

Project #450 Bird Sounds (IV)

OBJECTIVE: *To create bird sounds.*

Use the circuit in project #447. Connect the whistle chip (WC) across points B & C.

Project #451 Bird Sounds (V)

OBJECTIVE: *To create bird sounds.*

Using the jumper wires, connect the whistle chip (WC) across points C & D.

Project #452 Touch-Control Bird Sound

OBJECTIVE: *Show variations of project #447.*

Use the circuit in project #447. Replace the 100kΩ resistor (R5) with the photoresistor (RP). Wave your hand over the resistor and the sound changes. With the photoresistor installed, redo projects #448 - 451.



Project #453

Motor Sound Recording

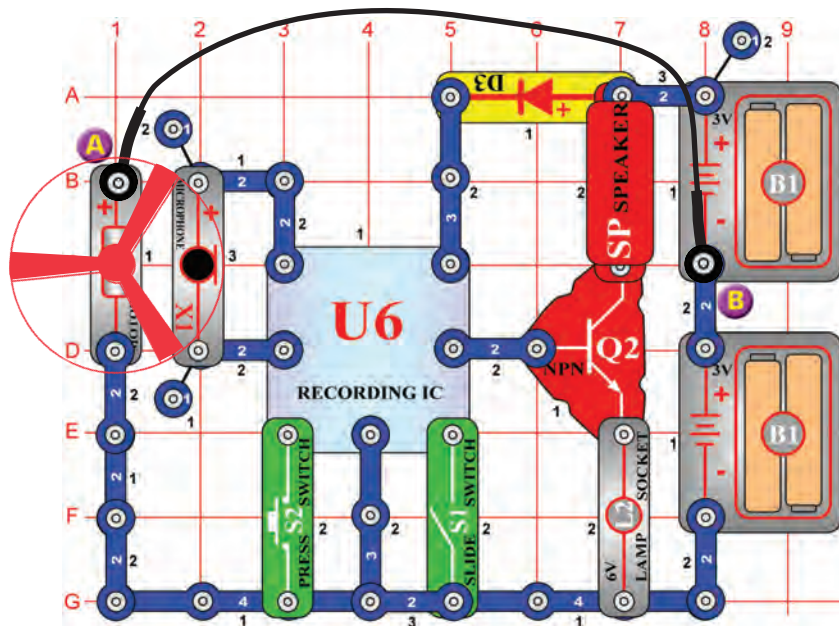

OBJECTIVE: Build a circuit that records the sound of the motor spinning.

Placing the motor (M1) (with the fan attached) next to the microphone (X1) enables you to record the sound as it spins. Turn off and then turn on the switch (S1). After the two beeps, turn off the slide switch (S1) again. Remove the jumper wire connected across points A & B and press the press switch (S2) to hear the recording. The lamp (L2) is used to limit the current and will not light.



WARNING: Moving parts. Do not touch the fan or motor during operation. Do not lean over the motor.



Project #454

Motor Sound Indicator

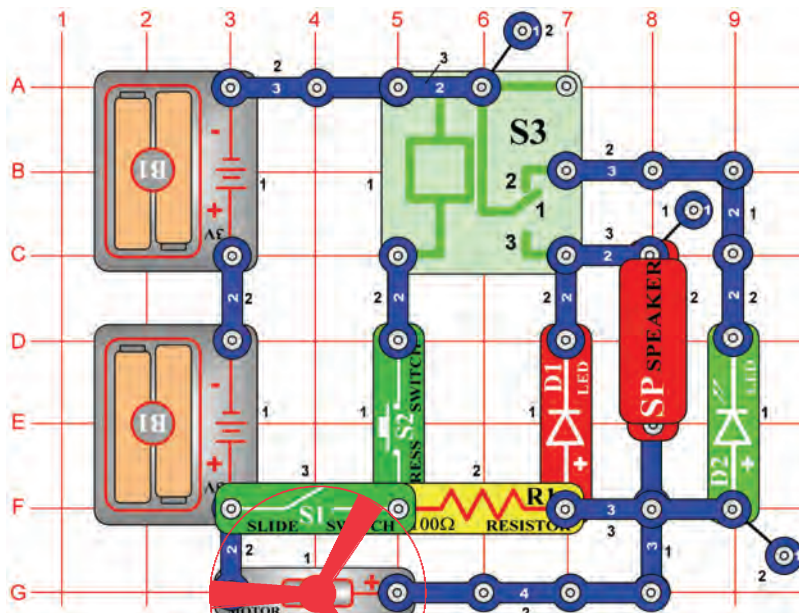

OBJECTIVE: To build a circuit that generates sound as a motor is spinning.

Turn off the switch (S1). There is no power; the LED's and motor are off. Now turn on the switch (S1). Only the green LED (D2) lights, indicating power to the circuit. Press the switch (S2). The motor spins, the red LED (D1) lights, and you hear the motor sound from the speaker (SP).



WARNING: Moving parts. Do not touch the fan or motor during operation. Do not lean over the motor.



Project #455

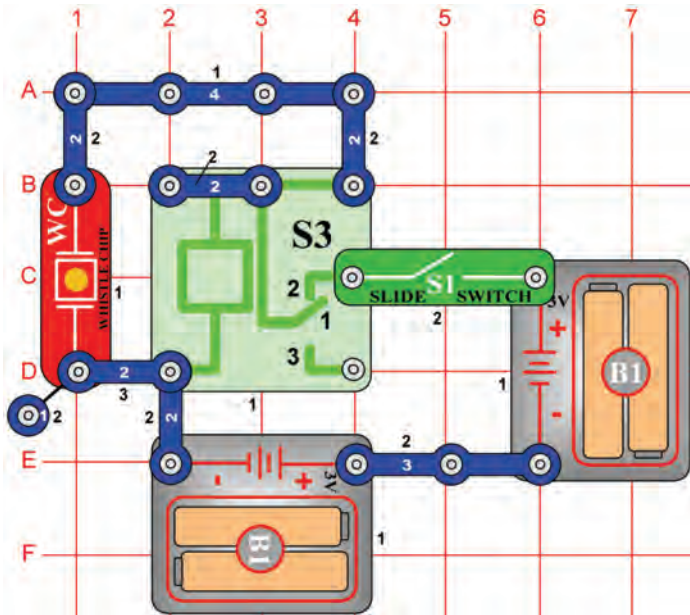

OBJECTIVE: Use the whistle chip and relay to make sound.

Turn on the slide switch (S1) and the relay (S3) opens and closes continuously. This creates an AC voltage across the whistle chip (WC), causing it to vibrate and sound.



Project #456 Relay & Speaker

OBJECTIVE: Use the speaker and relay to make sound.

Use the circuit from project #455. Replace the whistle chip (WC) with the speaker (SP). Turn on the slide switch (S1) and now you generate a louder sound using the speaker.

Next, replace the whistle chip (WC) with the 6V lamp (L2). Turn on the slide switch (S1) and the lamp lights.



Project #457

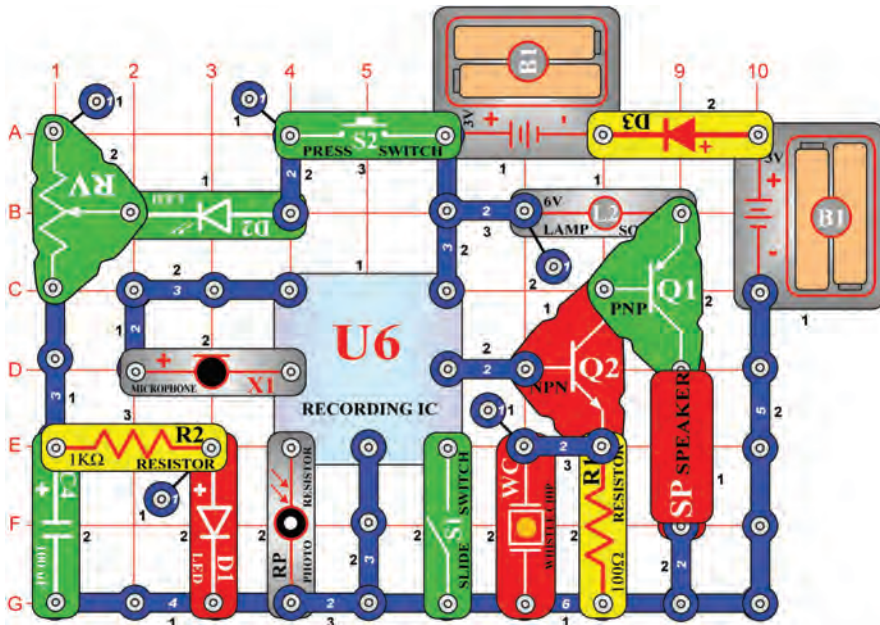

Electronic Playground

OBJECTIVE: To see how much fun electronics can be.

Uncover the photoresistor (RP) to play a recorded message followed by music, cover it to stop the music.

Turn on the slide switch (S1), you hear a beep signaling that you may begin recording. Talk into the microphone (X1) up to 5 seconds, and then turn off the slide switch (it also beeps after the 5 seconds expires).

Set the lever on the adjustable resistor (RV) down (towards the microphone). Push and release the press switch (S2); the green LED (D2) flashes once while the red LED (D1) stays on longer. The LEDs will be brighter if your batteries are new.

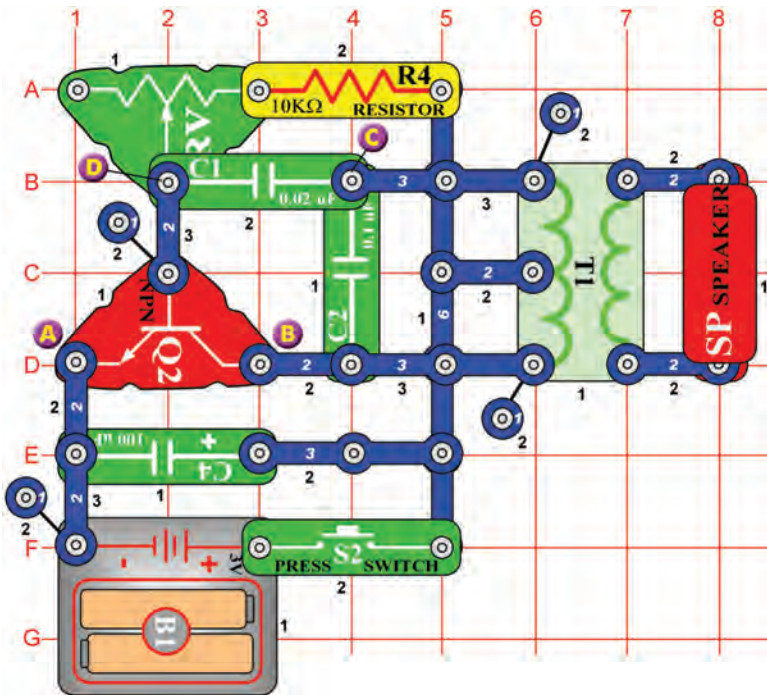

Project #458 Electronic Cat

OBJECTIVE: To create the sound of a cat.

Set the adjustable resistor (RV) to the far left. Press and release the switch (S2). You should hear the sound of a cat from the speaker (SP). Now adjust the resistor and hear the different sounds.

Project #459 Electronic Cat (II)

OBJECTIVE: Show variations of project #458.

Use the circuit in project #458. Connect the whistle chip (WC) across points A & B. Press and release the the switch (S2). You hear sound from the whistle chip and speaker (SP). Adjust the resistor (RV) and hear the different sounds.

Project #460 Electronic Cat (III)

OBJECTIVE: Show variations of project #458.

Use the circuit in project #458. Using the jumper wires, connect the whistle chip (WC) across points B & C. Press and release the switch (S2). Adjust the resistor (RV) and hear the different sounds.

Project #461 Electronic Cat (IV)

OBJECTIVE: Show variations of project #458.

Use the circuit in project #458. Connect the whistle chip (WC) across points C & D. Press and release the switch (S2). Adjust the resistor (RV) and hear the different sounds.

Project #462 Buzzer Cat

OBJECTIVE: Show variations of project #458.

Use the circuit in project #458. Remove the speaker (SP) and connect the whistle chip (WC) across points A & B. Press and release the press switch (S2) to hear the sounds.

Project #463 Buzzer Cat (II)

OBJECTIVE: Show variations of project #458.

Use the circuit in project #458. Remove the speaker (SP) and, using the jumper wires, connect the whistle chip (WC) across points B & C. Press and release the switch (S2). Adjust the resistor (RV) and hear the different sounds.

Project #464 Buzzer Cat (III)

OBJECTIVE: Show variations of project #458.

Use the circuit in project #458. Remove the speaker (SP) and connect the whistle chip (WC) across points C & D. Press and release the switch (S2). Adjust the resistor (RV) and hear the different sounds.

Project #465 Lazy Cat

OBJECTIVE: Show variations of project #458.

Use the circuit in project #458. Replace the 100µF capacitor (C4) with 470µF (C5). Repeat projects #459-464 and hear 7 different sounds.



Project #466

Meter Deflection (II)

OBJECTIVE: To build change the direction in which current flows.

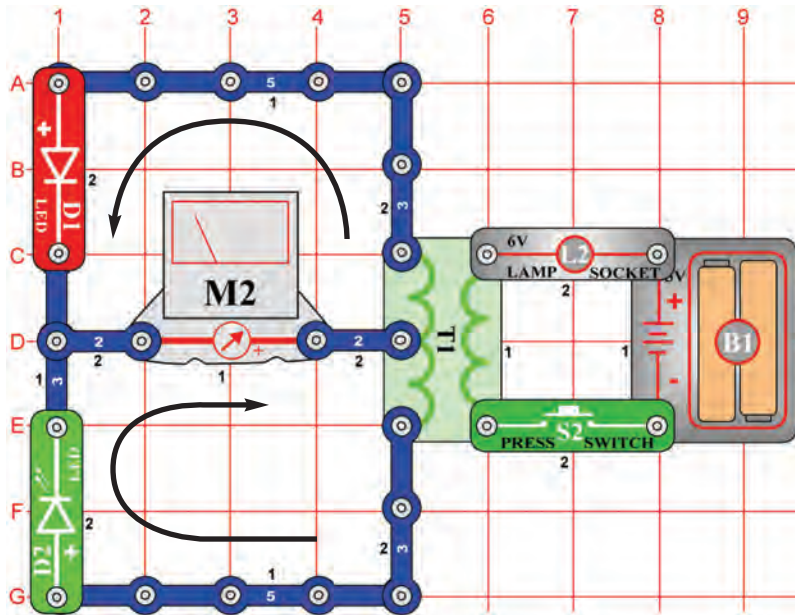

Compare this circuit to project #358, which has the LED (D1 & D2) positions reversed. This changes the direction that current can flow. Set the meter (M2) to the LOW (or 10mA) scale. Press the press switch (S2) and now the meter deflects to the left.



Project #467 Automatic Display #1

OBJECTIVE: Construct a light-controlled display.

Connect segments B & C to the circuit. Turn on the switch (S1), the display should be off. Place your hand over the photoresistor (RP), now the number 1 lights.



Project #468 Automatic Display #2

OBJECTIVE: Light the number 2 using a light-controlled display.

Use the circuit from project #467. Connect A, B, G, E, & D to the circuit. Turn on the switch (S1), the display should be off. Place your hand over the photoresistor (RP), now the number 2 lights.

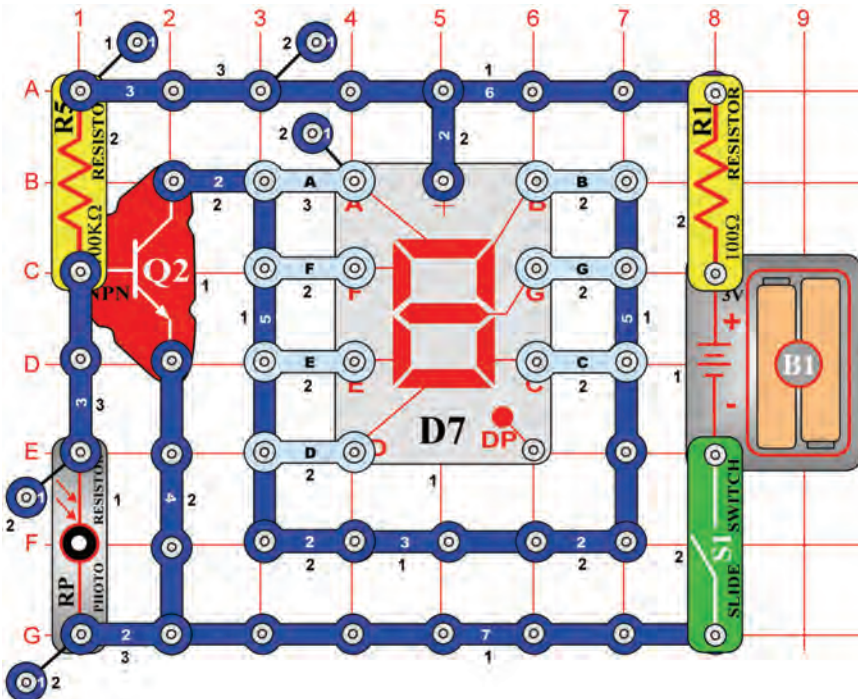

Project #469
Automatic Display #3

OBJECTIVE: Light the number 3 using a light-controlled display.

Use the circuit from project #467. Connect A, B, G, C, & D to the circuit. Turn on the switch (S1), the display should be off. Place your hand over the photoresistor (RP), now the number 3 lights.

Project #470
Automatic Display #4

OBJECTIVE: Light the number 4 using a light-controlled display.

Use the circuit from project #467. Connect B, G, C, & F to the circuit. Turn on the switch (S1), the display should be off. Place your hand over the photoresistor (RP), now the number 4 lights.

Project #471
Automatic Display #5

OBJECTIVE: Light the number 5 using a light-controlled display.

Use the circuit from project #467. Connect A, C, F, G, & D to the circuit. Turn on the switch (S1), the display should be off. Place your hand over the photoresistor (RP), now the number 5 lights.

Project #472
Automatic Display #6

OBJECTIVE: Light the number 6 using a light-controlled display.

Use the circuit from project #467. Connect A, C, D, E, F, & G to the circuit. Turn on the switch (S1), the display should be off. Place your hand over the photoresistor (RP), now the number 6 lights.

Project #473
Automatic Display #7

OBJECTIVE: Light the number 7 using a light-controlled display.

Use the circuit from project #467. Connect A, B, & C to the circuit. Turn on the switch (S1), the display should be off. Place your hand over the photoresistor (RP), now the number 7 lights.

Project #474
Automatic Display #8

OBJECTIVE: Light the number 8 using a light-controlled display.

Use the circuit from project #467. Connect A, B, C, D, E, F & G to the circuit. Turn on the switch (S1), the display should be off. Place your hand over the photoresistor (RP), now the number 8 lights.

Project #475
Automatic Display #9

OBJECTIVE: Light the number 9 using a light-controlled display.

Use the circuit from project #467. Connect A, B, D, F, G, & C to the circuit. Turn on the switch (S1), the display should be off. Place your hand over the photoresistor (RP), now the number 9 lights.

Project #476
Automatic Display #0

OBJECTIVE: Light the number 0 using a light-controlled display.

Use the circuit from project #467. Connect A, B, C, D, E & F to the circuit. Turn on the switch (S1), the display should be off. Place your hand over the photoresistor (RP), now the number 0 lights.

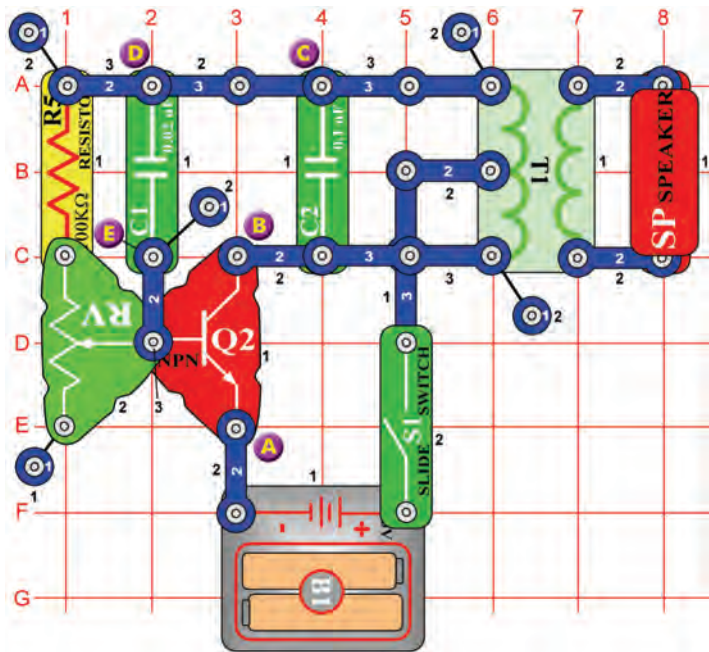

Project #477 Variable Oscillator

OBJECTIVE: To change the tone using the adjustable resistor.

Set the adjustable resistor (RV) to the bottom position. Turn on the slide switch (S1) and you should hear sound from the speaker (SP). Adjust the resistor to hear the different sounds.



Project #478 Variable Oscillator (II)

OBJECTIVE: To change the tone using the adjustable resistor.

Use the circuit in project #477. Connect the whistle chip (WC) across points A & B and adjust the resistor (RV). You should hear a higher tone. This is generated by the whistle chip (WC).

Project #479 Variable Oscillator (III)

OBJECTIVE: Show variations of project #477.

Use the circuit in project #477. Connect the whistle chip (WC) across points B & C and adjust the resistor (RV).

Project #480 Variable Oscillator (IV)

OBJECTIVE: Show variations of project #477.

Use the circuit in project #477. Connect the whistle chip (WC) across points D & E and adjust the resistor (RV).

Project #481 Photo Variable Resistor

OBJECTIVE: Show variations of project #477.

Use the circuit in project #477. Replace the 100kΩ resistor (R5) with the photoresistor (RP). Wave your hand over the resistor and the sound changes. Adjust the resistor (RV) to make more sounds.

Project #482 Variable Whistle Chip Oscillator

OBJECTIVE: Show variations of project #477.

Use the circuit in project #477, remove the speaker (SP). Make three more sounds by placing the whistle chip (WC) across points, A & B, B & C, and D & E.

Project #483 Slow Adjusting Tone

OBJECTIVE: Show variations of project #477.

Use the circuit in project #477. Place the 10μF capacitor (C3) (+ towards the top) directly over the .02μF capacitor (C1). A tone is generated once or twice per second, depending on the resistor setting.

Project #484 Slow Adjusting Tone (II)

OBJECTIVE: Show a variation of project #483.

Use the circuit in project #483. Replace the 10μF capacitor (C3) with the 100μF capacitor (C4) and the tone is much slower. To make it even slower, replace the 100μF capacitor (C4) with the 470μF capacitor (C5).



Project #485

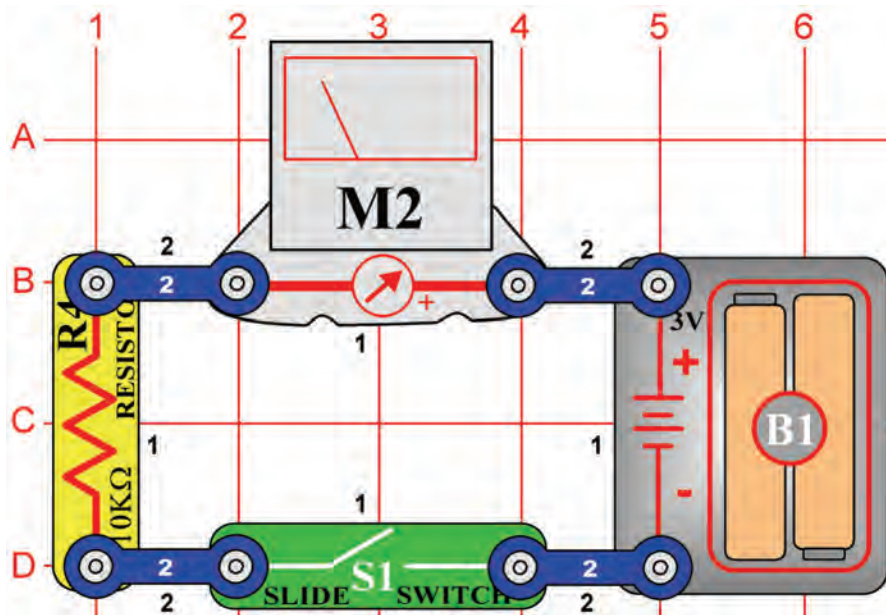

Fixed-Current Path

OBJECTIVE: To make a fixed-current path.

Set the meter (M2) to the LOW (or 10mA) setting. The meter indicates the amount of current in the circuit. Turn on the switch (S1), the needle deflects indicating the amount of current. The 10kΩ resistor limits the current, otherwise the meter could be damaged.



Project #486

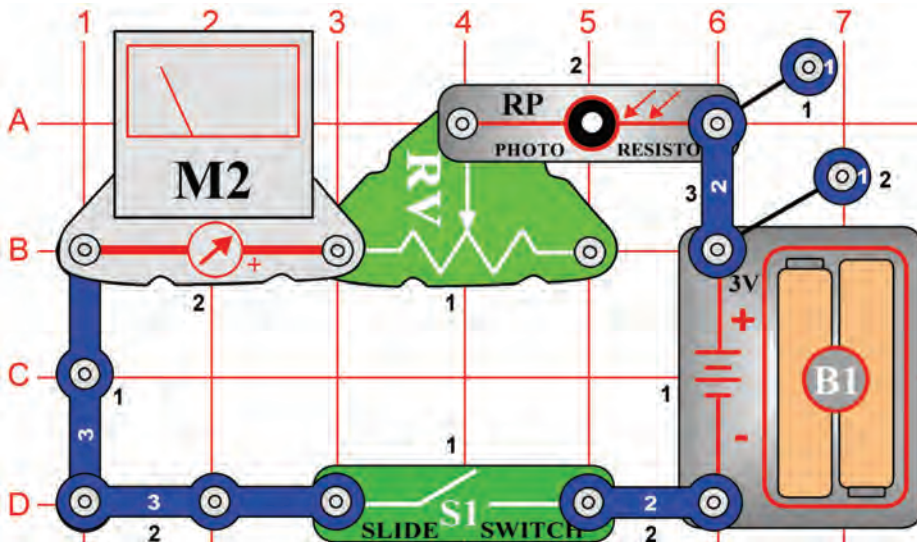

Simple Illumination Meter

OBJECTIVE: To make a simple light meter.

Set the meter (M2) to the LOW (or 10mA) setting. Using only a few parts, you can make a simple light meter. The amount of light changes the resistance of the photoresistor (RP), which affects the current through the meter. As light increases, the resistance drops and the meter deflects to the right. Decreasing the light, the meter deflects to the left, indicating less current.

Set the adjustable resistor (RV) to the far left and turn on the slide switch (S1). The circuit is now very sensitive to light. Wave your hand over the photoresistor (RP) and the meter deflects to the left, almost to zero. Move the adjustable resistor to the far right and see how less sensitive the circuit is to light now.



Project #487

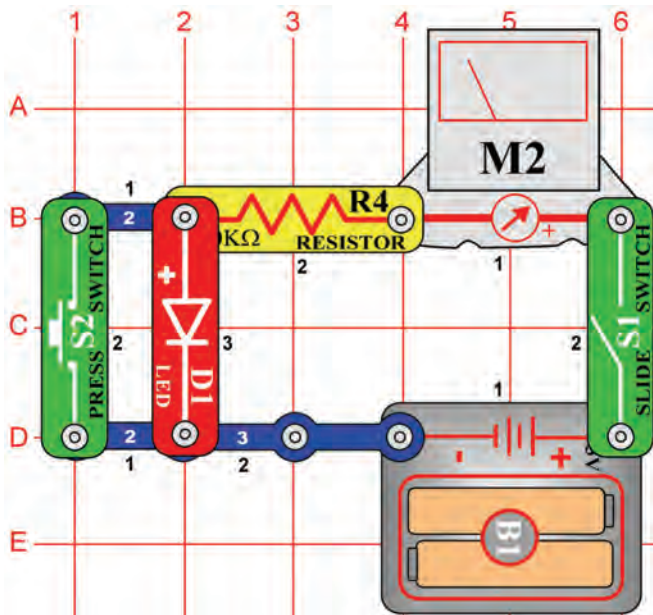

LED Voltage Drop

OBJECTIVE: To measure the voltage drop across diodes.

Set the meter (M2) to the LOW (or 10mA) setting. Turn on the slide switch (S1) and the LED (D1) lights as the meter deflects to the middle of the scale. The sum of the voltage drop across each component equals the battery voltage. Bypass the LED by pressing the switch (S2). The voltage across the 10kΩ resistor increases, as shown by the meter deflecting more to the right. Replace the red LED with the green LED (D2) and then the diode (D3), to see the different voltage drops.



Project #488

Open/Closed Door Indicator

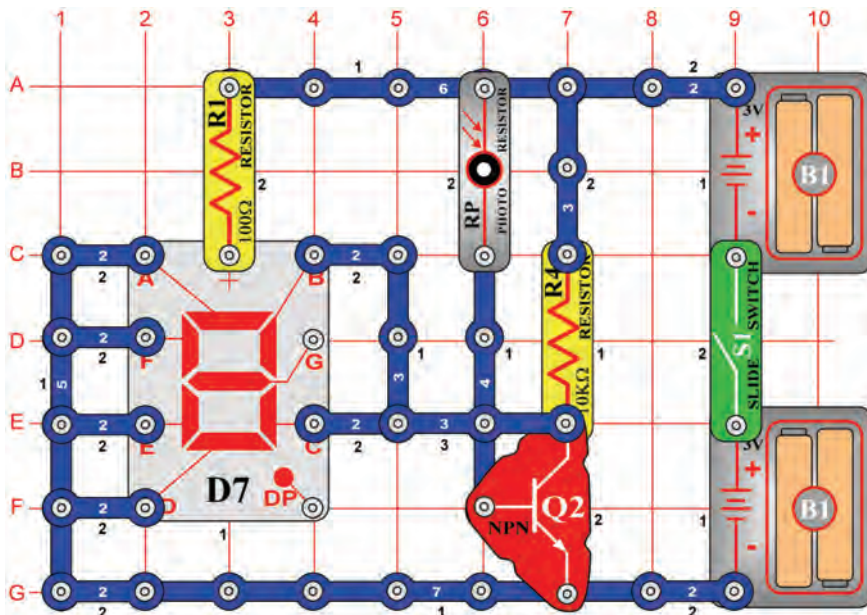

OBJECTIVE: To make a circuit that indicates whether a door is open or closed.

Using the photoresistor (RP) you can build a circuit that indicates if a door is open or closed. When the door is open and light is present, the letter "O" lights. When the door is closed and the room is dark, the letter "C" lights.

The photoresistor turns the transistor (Q2) on or off, depending on the amount of light in the room. When the transistor is on (light present), segments B & C connect to the (-) side of the batteries and letter "O" lights. When the room is dark, the transistor is off and the letter "C" lights. Segments B & C are connected to the transistor.

Turn the slide switch (S1) on and the letter "O" should light. Cover the photoresistor, simulating closing the door, and the letter "C" lights.



Project #489

Hand-control Meter

OBJECTIVE: To understand music deflection.

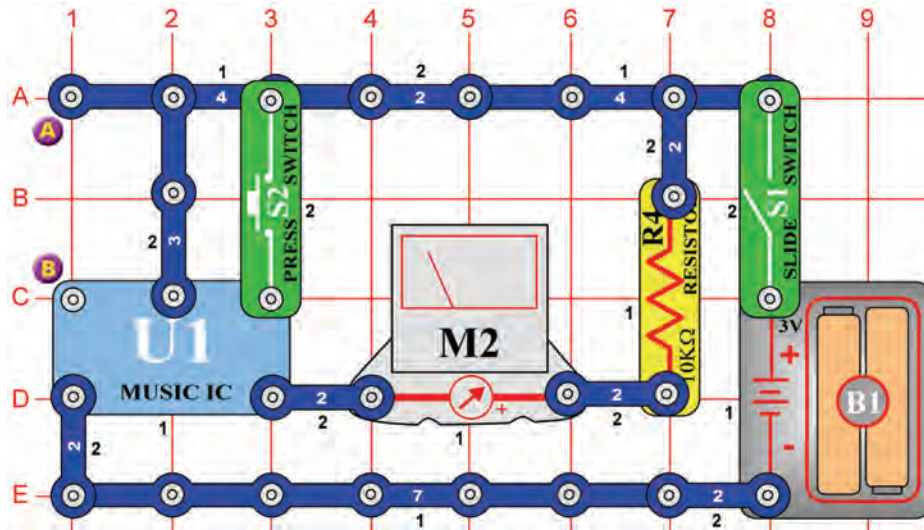

Set the meter (M2) to the LOW (or 10mA) setting. Instead of driving a speaker (SP) with the music IC (U1), you can see it by using the meter. Turn on the slide switch (S1) and the meter deflects according to the rhythm of music. After the music stops, hold down the press switch (S2) to make it continue.

Project #490

Light-control Meter

OBJECTIVE: To control the circuit using light.

Use the circuit in project #489. Replace the press switch (S2) with the photoresistor (RP). The music IC (U1) outputs a signal, as long as a light is present on the photoresistor. The photoresistor is like a short, connecting the pin to the battery. When the song repeats, cover the photoresistor with your hand, the resistance goes up, and the music stops.

Project #491

Electric-control Meter

OBJECTIVE: To start the circuit using an electric motor.

Use the circuit in project #489. Place the motor (M1) across points A & B. Turn on the slide switch (S1) and the meter (M2) deflects and swings according to the rhythm of music. When deflection stops, rotate motor to start the music again. The voltage generated by the motor triggers the IC again.

Project #492

Sound-control Meter

OBJECTIVE: To start the circuit by using the whistle chip.

Use the circuit in project #489. Place the whistle chip (WC) across points A & B. Turn on the slide switch (S1) and the meter (M2) deflects and swings according to the rhythm of music. When deflection stops, clap your hands next to the whistle chip, the music plays again. The clapping sound vibrates the plates in the whistle chip, creating the voltage needed to trigger the IC.



Project #493

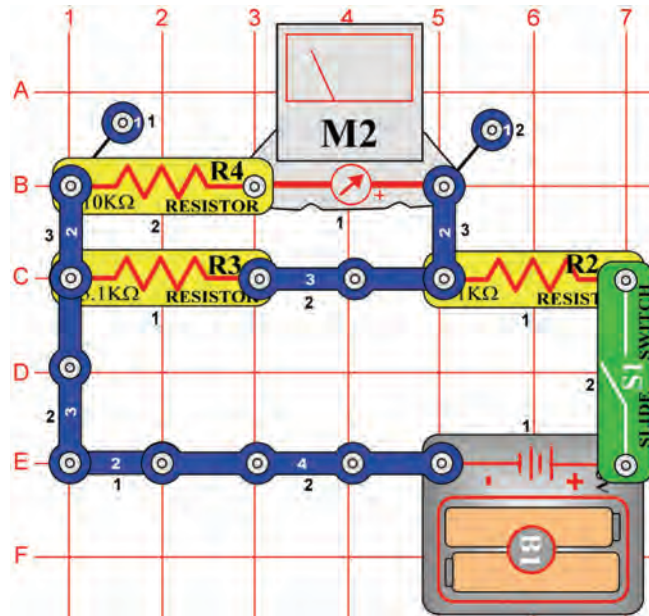

Fixed-Voltage Divider

OBJECTIVE: *To make a simple voltage divider.*

Set the meter (M2) to the LOW (or 10mA) scale. This circuit is a simple voltage divider with parallel load resistors. The voltage across resistors R3 & R4 is the same. The current through both paths are different, due to the resistor values. Since resistor (R3) (5.1kΩ) is half the value of resistor (R4) (10kΩ), twice the current flows through R3.

The lights in a house are an example of this type of circuit. All are connected to the same voltage, but the current is dependent on the wattage of the bulb.



Project #494

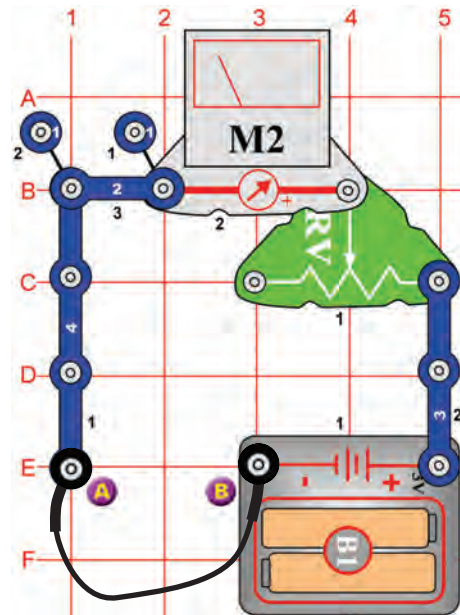

Resistor Measurement

OBJECTIVE: *To make a resistor checker.*

Set the meter (M2) to the LOW (or 10mA) setting. Connect the jumper wire to points A & B. Adjust the adjustable resistor (RV) so the meter deflects to 10. The resistance between points A & B is zero. Remove the jumper wire and put the 100Ω resistor (R1) across points A & B. The meter deflects to the 10, indicating a low resistance. Now replace resistor (R1) with the other resistors. The meter will display different readings for each resistor.

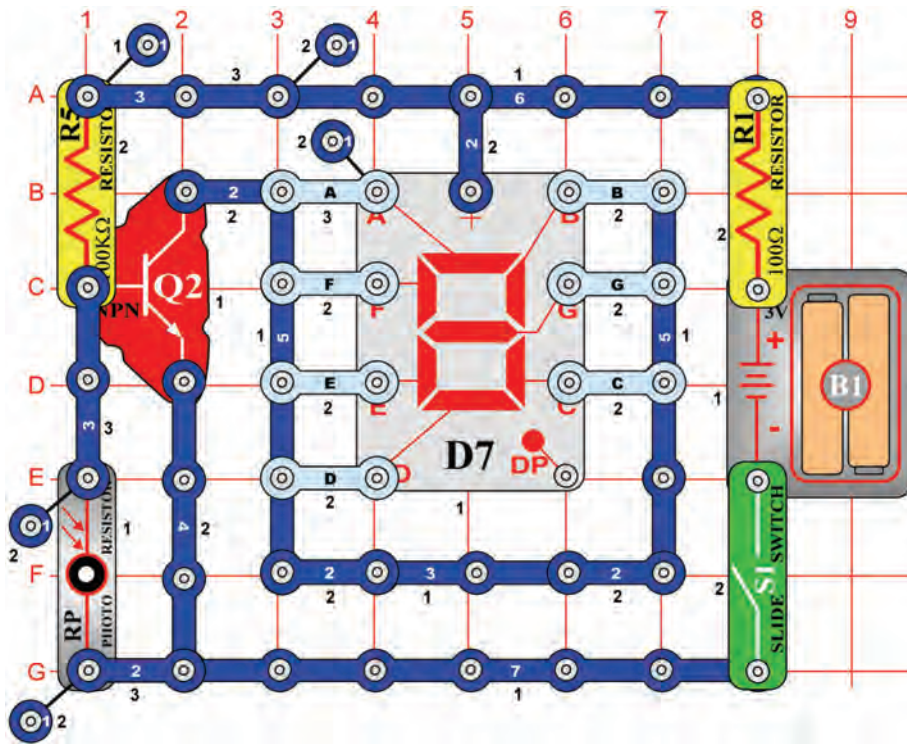

Project #495 Automatic Display Letter “b”

OBJECTIVE: To construct a light-controlled display for lower case letters.

Connect C, D, E, F & G to the circuit. Turn on the slide switch (S1) and the display should be off. Place your hand over the photoresistor (RP), now the letter “b” lights.

Project #496 Automatic Display Letter “c”

OBJECTIVE: To light the letter “c” using a light-controlled display.

Use the circuit from project #495. Connect E, D, & G to the circuit. Turn on the slide switch (S1) and the display should be off. Place your hand over the photoresistor (RP), now the letter “c” lights.

Project #497 Automatic Display Letter “d”

OBJECTIVE: To light the letter “d” using a light-controlled display.

Use the circuit from project #495. Connect B, C, D, E, & G to the circuit. Turn on the slide switch (S1) and the display should be off. Place your hand over the photoresistor (RP), now the letter “d” lights.

Project #498 Automatic Display Letter “e”

OBJECTIVE: To light the letter “e” using a light-controlled display.

Use the circuit from project #495. Connect A, B, D, E, F, & G to the circuit. Turn on the slide switch (S1) and the display should be off. Place your hand over the photoresistor (RP), now the letter “e” lights.

Project #499 Automatic Display Letter “h”

OBJECTIVE: To light the letter “h” using a light-controlled display.

Use the circuit from project #495. Connect F, E, C, & G to the circuit. Turn on the slide switch (S1) the display should be off. Place your hand over the photoresistor (RP), now the letter “h” lights.

Project #500 Automatic Display Letter “o”

OBJECTIVE: To light the letter “o” using a light controlled display.

Use the circuit from project #495. Connect C, D, E, and G to the circuit. Turn on the slide switch (S1) the display should be off. Place your hand over the photoresistor (RP), now the letter “o” lights.

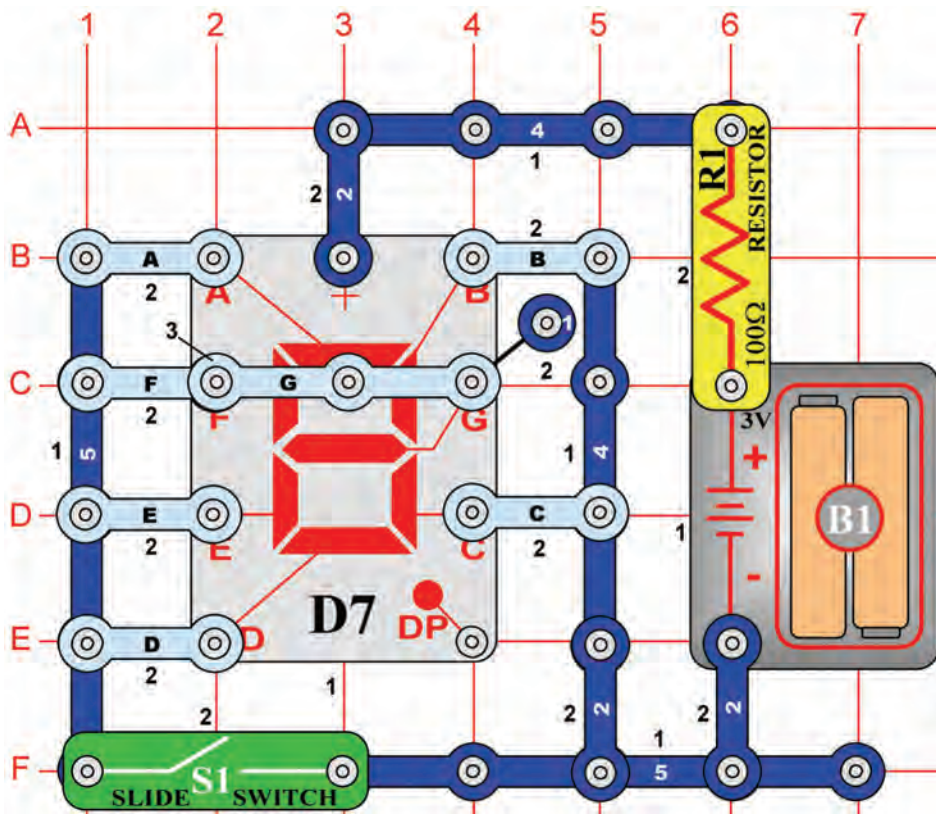

Project #501 Hand-Control Display 1 & 4

OBJECTIVE: Display numbers 1 or 4 using the slide switch.

Connect segments B, C, F, & G as shown in the diagram. Turn the slide switch (S1) off and on, the display changes from numbers 1 to 4.

Project #502 Hand-Control Display 1 & 0

OBJECTIVE: Display numbers 1 or 0 using the slide switch.

Connect segments A, B, C, D, E, & F as shown in the diagram. Turn the slide switch (S1) off and on, the display changes from numbers 1 to 0.

Project #503 Hand-Control Display 1 & 7

OBJECTIVE: Display numbers 1 or 7 using the slide switch.

Connect segments A, B, & C as shown in the diagram. Turn the slide switch (S1) off and on, the display changes from numbers 1 to 7.

Project #504 Hand-Control Display 1 & 8

OBJECTIVE: Display numbers 1 or 8 using the slide switch.

Connect segments A, B, C, D, E, F, & G as shown in the diagram. Turn the slide switch (S1) off and on, the display changes from numbers 1 to 8.

Project #505 Hand-Control Display 1 & 9

OBJECTIVE: Display numbers 1 or 9 using the slide switch.

Connect segments A, B, C, D, F, & G as shown in the diagram. Turn the slide switch (S1) off and on, the display changes from numbers 1 to 9.



Project #506

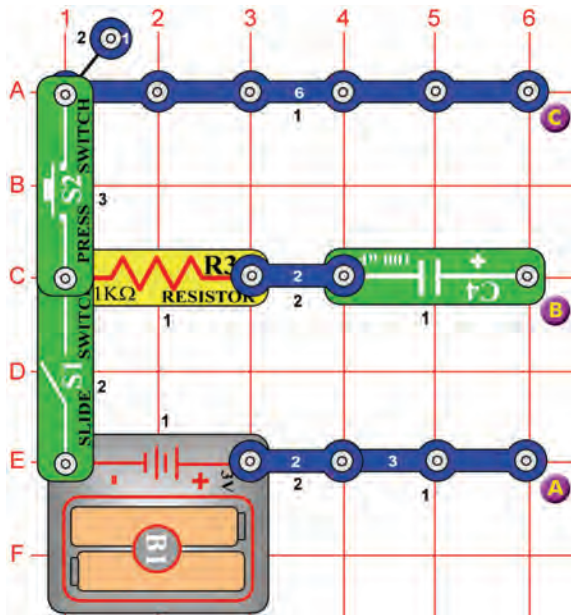

Monitor Capacitor Charging & Discharging

OBJECTIVE: View charging and discharging a capacitor.

Using the meter (M2), we can monitor the charging and discharging of a capacitor. First turn off the switch (S1).

Charging: Connect the meter (M2) to points A & B (positive pole downward). Turn on the switch (S1). The 100µF capacitor (C4) charges and the meter deflects, slowly returning to zero.

Discharging: Connect the meter to points B & C (positive pole downward). Press the switch (S2). The capacitor discharges and the meter deflects, slowly returning to zero.



Project #507

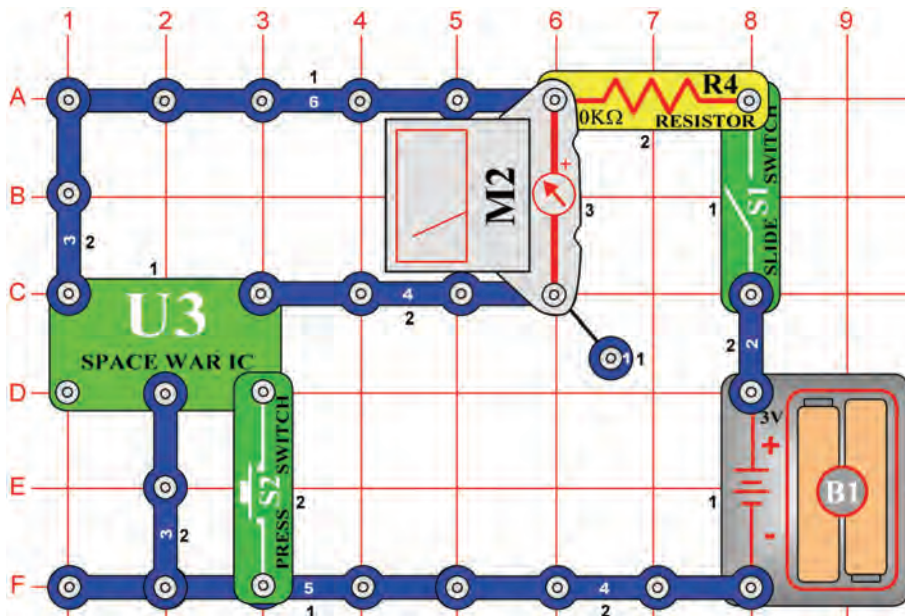

Hand-Control Space Meter

OBJECTIVE: Using the meter with the space war IC.

Set the meter (M2) to the LOW (or 10mA) setting. This is another circuit using the meter to monitor the output of an IC.

Turn on the switch (S1). Press switch (S2) to start the circuit. As the space war IC (U3) outputs a signal, the meter will deflect. When the circuit stops, start it again by pressing switch (S2).



Project #508

Rhythm Swinging Meter

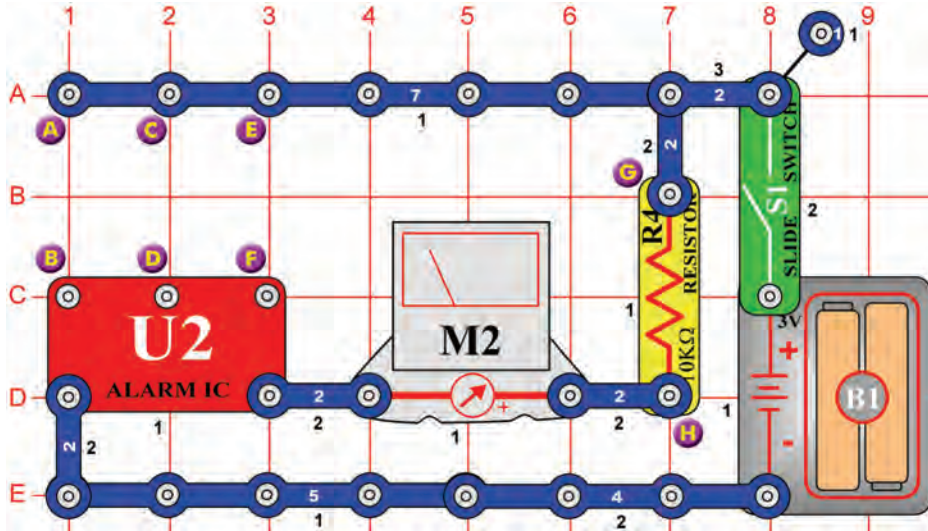

OBJECTIVE: Use the meter with the alarm IC.

Set the meter (M2) to the LOW (or 10mA) setting. Connect 3-snap wires to terminals E & F, and C & D. Turn on the slide switch (S1) and the meter swings rhythmically.



Project #509 Police Car Sound with Whistle Chip

OBJECTIVE:
Show variations of project #508.

Use the circuit in project #508. Connect the whistle chip (WC) to points G & H. Connect a 3-wire snap to the terminals C & D and turn on the switch (S1).



Project #510 Fire Engine Sound with Whistle Chip

OBJECTIVE:
Show variations of project #508.

Connect 3-wire snaps to terminals C & D and A & B. Connect the whistle chip (WC) across points G & H. You should hear a fire engine sound generated by the alarm IC (U2).



Project #511 Ambulance Sound with Whistle Chip

OBJECTIVE:
Show variations of project #508.

Connect a 3-wire snap to terminals C & D. Connect the whistle chip (WC) across points G & H. Connect a jumper wire to terminals B & H. You should hear an ambulance sound generated by the alarm IC (U2).

OTHER SNAP CIRCUITS® PRODUCTS!

For a listing of local toy retailers who carry Snap Circuits®, please visit www.elenco.com or call us toll-free at (800) 533-2441. For Snap Circuits® upgrade kits, accessories, additional parts, and more information about your parts, please visit www.snapcircuits.net.

Upgrade Kit Model UC-80



- Build 250 Additional Projects**
- Including:**
- Strobe light
 - Electromagnetism
 - Transistor AM radio
 - Rechargeable battery
 - Solar batteries
 - Mega pulser and flasher
 - Paperclip compass
 - Plus all experiments contained in the 500-in-1 (SC-500)!
 - Includes CI-73 Computer Interface!
- Contains 10 New Parts**
- Including:**
- Solar cell
 - Electromagnet
 - Vibration switch
 - Two-spring socket
 - Bag of paperclips

Put your circuits in motion! Deluxe Snap Rover® Model SCROV-50



Introducing the next generation of the RC Snap Rover®! This version includes a disc launcher, digital voice recorder, and music sounds. Over 50 parts allow you to complete over 40 additional projects.

- Includes 30 parts
- Full-color assembly manual
- Build over 20 projects
- Sound effects

Snap Circuits® Green Alternative Energy Kit Model SCG-125

Learn about energy sources and how to “think green”. Build over 125 projects and have loads of fun learning about environmentally-friendly energy and how the electricity in your home works. Includes full-color manual with over 100 pages and separate educational manual. This educational manual will explain all the forms of environmentally-friendly energy including: geothermal, hydrogen fuel cells, wind, solar, tidal, hydro, and others. Contains over 40 parts.

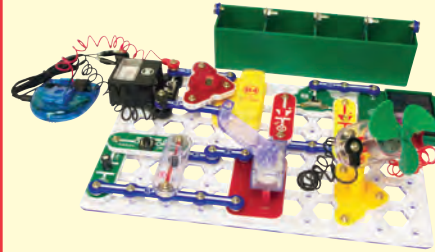

Snap Circuits® LIGHT Model SCL-175

Build over 175 projects!

Contains over 60 parts

Features:

- Infrared detector
- Strobe light
- Color changing LED
- Glow-in-the-dark fan
- Strobe integrated circuit (IC)
- Fiber optic communication
- Color organ controlled by iPod® or other MP3 player, voice, and fingers.

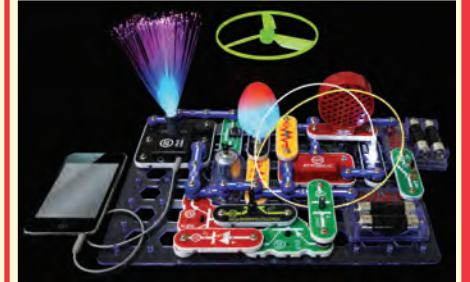

Motion Detector Model SCP-03

Whenever somebody walks in front of the Motion Detector, the sound of a laser comes out of the speaker!



Snaptricity

Model SCBE-75

Build Over 75 Projects

Learn how electricity and magnetism can be used to make each other, learn about magnetic fields, how the electricity in your home works, how switches control the electricity to the lights in your home, and how series and parallel circuits affect electricity.

Over 40 parts including: Meter, electromagnet, motor, lamps, switches, fan, compass, and electrodes.

Educational Toy: Projects that relate to electricity in the home and magnetism and how it is used. Build over 75 projects.

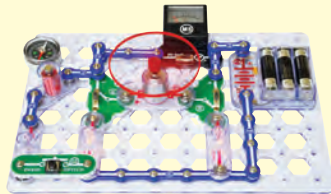

If you want to enhance your Snap Circuits® experience and get even smarter, then try

Snap Circuits® Student Guide

Part # 753307

For use with SC-500

Educational Series - teaches Basic Electricity and Electronics in the everyday world using our Learn By Doing® concept!

80 full-color pages, and written with the help of educators.



Custom Storage Case

Model SNAPCASE7

Heavy duty plastic case with 2 custom foam inserts for housing your Snap Circuits® parts. Easy to identify missing components. Also includes a separate small case to hold the smaller loose parts.



(for use with SC-500)

Expansion Parts

AC Power Supply

Part # AC-SNAP

Replaces the batteries in Snap Circuits®.



Snap-to-Pin Set

Part # 9JWSC10

Lets you connect Snap Circuits® to a breadboard. 10 wires with reinforced pins, 5 colors, 10" length, and unlimited possibilities!



Two-spring Socket

Part # ?1



Three-spring Socket

Part # ?Q



Eight-Pin IC Socket

Part # ?U8



Computer Interface for Snap Circuits®

Model CI-73

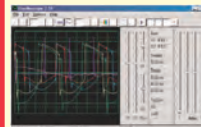

Sample Screen of Computer Experiment

With this module you will also learn about and use an oscilloscope and spectrum analyzer, as you build over **73 BONUS EXPERIMENTS** using your Windows-based PC. Comes with all of the interface parts you need and the software. Great for introducing electronics through a computer. Works with all versions of our Snap Circuits®.

Acts as a Scope and Allows You to See the Signals in the Circuit.

OTHER FUN ELENCO® PRODUCTS

RC Car Kit Model FUN-875

Your Turbo King Car will be built from the ground up. You'll learn all about gears, motors, printed circuit boards, and integrated circuits from our detailed assembly and training manual. You will construct each section, explore the circuitry and troubleshoot it.



Titan Tank Kit Model 21-531N

The Titan Tank is an infrared remote control kit. Its microprocessor provides four different channels that allow up to four Titans to fight each other at the same time. Makes a sound when shooting and when it is hit. The Titan moves using six wheels that can move forward, backward, right and left.



300-in-1 Project Lab Model MX-908

This lab has everything you need to build 300 exciting electronic projects. It uses spring and breadboard hook-up methods and includes an easy-to-read, illustrated, tab-style manual. Projects include: Transistor Radio, Burglar Alarm, Metal Detector, and much more!



Detectolab Model EDU-708

Investigate, analyze, decipher and solve the crime! Over 65 activities with fingerprints, secret messages, chromatography, cipher codes, identity detection and more... Kit includes 30X microscope and necessary lab equipment.





ELENCO®

150 Carpenter Avenue
Wheeling, IL 60090
(847) 541-3800

Website: www.elenco.com
e-mail: elenco@elenco.com